

LANIER
General Settings Guide
LD225/LD230

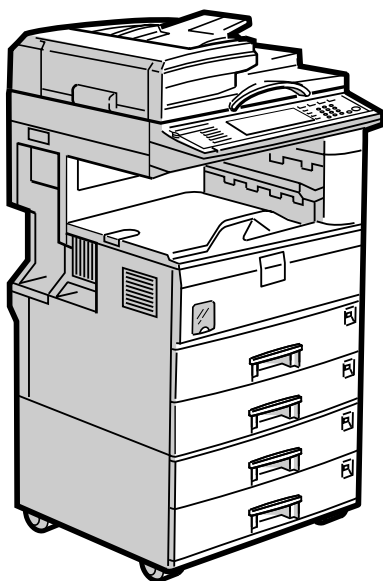

Introduction

This manual contains detailed instructions and notes on the operation and use of this machine. For your safety and benefit, read this manual carefully before using the machine. Keep this manual in a handy place for quick reference.

For safe and correct use of this machine, please be sure to read the Safety Information before you use it.

Important

Contents of this manual are subject to change without prior notice. In no event will the company be liable for direct, indirect, special, incidental, or consequential damages as a result of handling or operating the machine.

Notes:

Some illustrations in this manual might be slightly different from the machine.

Certain options might not be available in some countries. For details, please contact your local dealer.

Laser Safety:

This machine is considered a class 1 laser device, safe for office/EDP use. The machine contains two GaAlAs laser diodes, 5-milliwatt, 760-800 nanometer wavelength for each emitter. Direct (or indirect reflected) eye contact with the laser beam might cause serious eye damage. Safety precautions and interlock mechanisms have been designed to prevent any possible laser beam exposure to the operator.

The following label is attached on the back side of the machine.

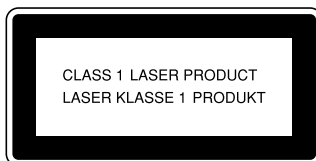

Caution:

Use of controls or adjustments or performance of procedures other than those specified in this manual might result in hazardous radiation exposure.

Notes:

The model names of the machines do not appear in the following pages. Check the type of your machine before reading this manual. (For details, see p.15 "Machine Types".)

- Type 1: LD225
- Type 2: LD230

Certain types might not be available in some countries. For details, please contact your local dealer.

Two kinds of size notation are employed in this manual. With this machine refer to the metric version.

For good copy quality, LANIER recommends that you use genuine LANIER toner.

LANIER shall not be responsible for any damage or expense that might result from the use of parts other than genuine LANIER parts in your LANIER office product.

Power Source

220 - 240V, 50/60Hz, 7A or more

Please be sure to connect the power cord to a power source as above. For details about power source, see p.144 "Power Connection".

Manuals for This Machine

The following manuals describe the operational procedures of this machine. For particular functions, see the relevant parts of the manual.

Note

- Manuals provided are specific to machine type.
- Adobe Acrobat Reader/Adobe Reader is necessary to view the manuals as a PDF file.
- Two CD-ROMs are provided:
 - CD-ROM 1 “Operating Instructions”
 - CD-ROM 2 “Scanner Driver and Document Management Utility”

❖ **General Settings Guide (this manual) (PDF file - CD-ROM1)**

Provides an overview of the machine and describes System Settings (such as Tray Paper Settings), Document Server functions, and troubleshooting. Refer to this manual for Address Book procedures such as registering fax numbers, e-mail addresses, and user codes.

❖ **Security Reference**

This manual is for administrators of this machine. It describes security functions that the administrators can use to protect data from being tampered, or prevent the machine from unauthorized use.

Also refer to this manual for the procedures for registering administrators, as well as setting user and administrator authentication.

❖ **Network Guide (PDF file - CD-ROM1)**

Provides information about configuring and operating the printer in a network environment or using software.

This manual covers all models, and therefore contains functions and settings that may not be available for your model. Images, illustrations, functions, and supported operating systems may differ from those of your model.

❖ **Copy Reference (PDF file - CD-ROM1)**

Describes operations, functions, and troubleshooting for the machine's copier function.

❖ **Facsimile Reference <Basic Features> (PDF file - CD-ROM1)**

Describes operations, functions, and troubleshooting for the machine's facsimile function.

❖ **Facsimile Reference <Advanced Features> (PDF file - CD-ROM1)**

Describes advanced facsimile functions such as line settings and procedures for registering IDs.

❖ **Printer Reference (PDF file - CD-ROM1)**

Describes system settings, operations, functions, and troubleshooting for the machine's printer function.

❖ **Scanner Reference (PDF file - CD-ROM1)**

Describes operations, functions, and troubleshooting for the machine's scanner function.

❖ **Manuals for DeskTopBinder Lite**

DeskTopBinder Lite is a utility included on the CD-ROM labeled “Scanner Driver and Document Management Utility”.

- DeskTopBinder Lite Setup Guide (PDF file - CD-ROM2)
Describes installation of, and the operating environment for DeskTopBinder Lite in detail. This guide can be displayed from the **[Setup]** display when DeskTopBinder Lite is installed.
- DeskTopBinder Introduction Guide (PDF file - CD-ROM2)
Describes operations of DeskTopBinder Lite and provides an overview of its functions. This guide is added to the **[Start]** menu when DeskTopBinder Lite is installed.
- Auto Document Link Guide (PDF file - CD-ROM2)
Describes operations and functions of Auto Document Link installed with DeskTopBinder Lite. This guide is added to the **[Start]** menu when DeskTopBinder Lite is installed.

❖ **Other manuals**

- PS3 Supplement (PDF file - CD-ROM1)
- Unix Supplement (Available from an authorized dealer, or as a PDF file on our Web site.)

What You Can Do with This Machine

The following introduces the functions of this machine, and the relevant manuals containing detailed information about them.

Products marked with * are optional. For details about optional products, see p.156 "Options", or contact your local dealer.

Copier, Facsimile, Printer, and Scanner Functions

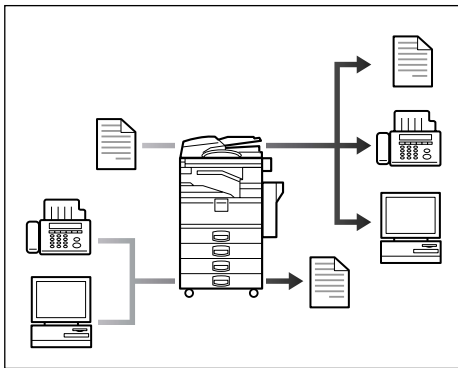

This machine provides copier, facsimile*, printer*, and scanner* functions.

- You can make copies of originals. With a finisher*, you can sort and staple copies. See *Copier Reference*.
- You can send originals by fax and receive faxes from other parties. See *Facsimile Reference <Basic Features>*, and *Facsimile Reference <Advanced Features>*.
- You can print documents created using applications. See *Printer Reference*.
- You can scan originals and send the scan file to a computer. See *Scanner Reference*.

Utilizing Stored Documents

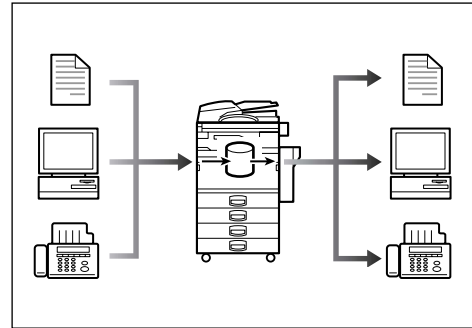

- You can store file from originals scanned by this machine, or file sent from other computers, into the machine's hard disk. You can print and fax stored documents as required. You can also change print settings and print multiple documents (Document Server). See p.37 "Using the Document Server".
- With DeskTopBinder Professional*/Lite, you can search, check, print, and delete stored documents using your computer. You can also retrieve stored documents scanned in scanner mode. File Format Converter*, you can even download documents stored in copy and printer functions to your computer. See *Network Guide*.

Paperless Fax Transmission and Reception

Reception

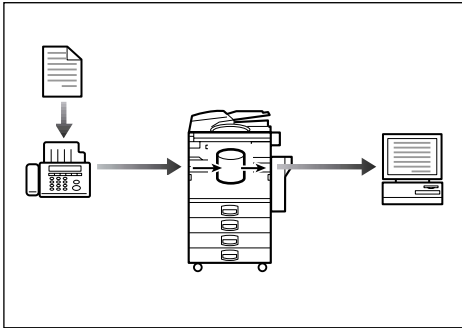

GCKONN3J

- You can store received fax messages on the machine's hard disk, instead of printing them onto paper. You can use ScanRouter Professional or a Web Image Monitor to check, print, delete, retrieve, or download documents using your computer (Storing received documents). See *Facsimile Reference <Advanced Features>*.

Transmission

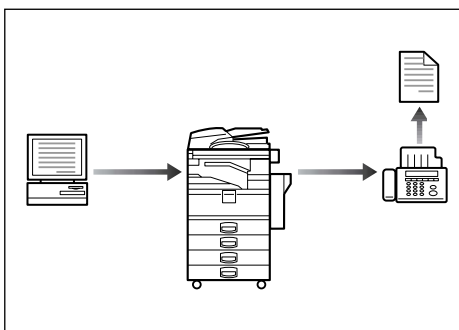

AHR003S

- You can send documents created using applications to another party's fax machine directly, without performing a print job (LAN-Fax). See *Facsimile Reference <Advanced Features>*.

Fax Transmission and Reception Through the Internet

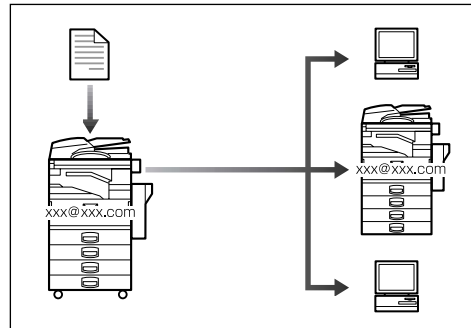

GCKONN9J

- You can send fax documents through e-mail by specifying the recipient's e-mail address (Internet Fax Transmission). You can receive sent documents via Internet Fax, or from computers (Internet Fax Reception). See *Facsimile Reference <Basic Features>*
- You can send faxes by using data such as the IP address to specify the IP-Fax destination (IP-Fax Transmission). The transmitted files can be received using an Internet fax machine (IP-Fax Reception). See *Facsimile Reference <Basic Features>*

Using the Scanner in a Network Environment

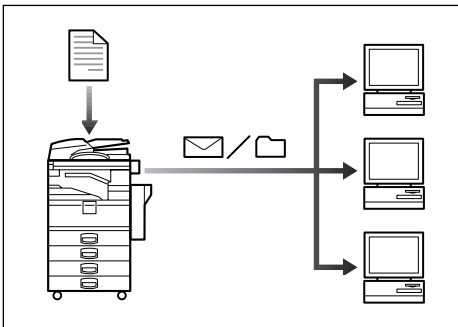

- You can send scanned documents to other network computers using e-mail (Sending stored scan file by e-mail). See *Scanner Reference*.
- With ScanRouter delivery software, you can save scanned documents in specified destinations on network computers (File storage). See *Scanner Reference*.
- You can send scanned documents to other network folders (Scan to Folder). See *Scanner Reference*

Administering the Machine/Protecting Documents (Security Functions)

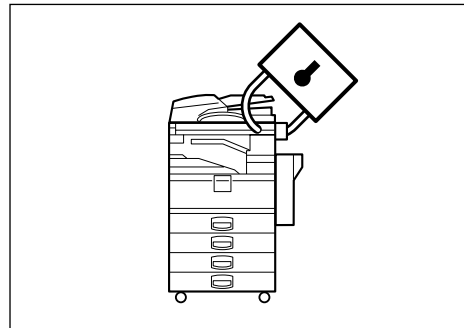

- You can protect documents from unauthorized access and stop them from being copied without permission. See *Security Reference*.
- You can control the use of the machine, as well as prevent machine settings from being changed without authorization. See *Security Reference*.
- By setting passwords, you can prevent unauthorized access via the network. See *Security Reference*.
- You can erase the data on the hard disk to prevent the information from leaking out. See the manual for the DataOverWriteSecurity Unit* and *Security Reference*.

Monitoring the Machine Via Computer

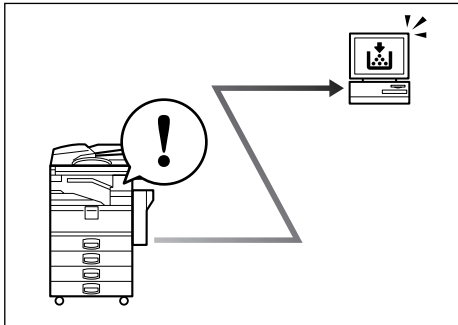

AHR0065

You can monitor machine status and change settings using a computer.

- Using SmartDeviceMonitor for Admin, SmartDeviceMonitor for Client, or a Web Image Monitor, you can use a computer to view the machine's status, such as to check on paper quantities, or misfeeds, etc. See *Network Guide*.
- You can also use a Web Image Monitor to make network settings. See *Network Guide*.
- You can also use a Web Image Monitor to register and manage items such as user codes, fax numbers, e-mail addresses, and folders in the Address Book. See the Web Image Monitor Help.
- Using Web Image Monitor, you can receive e-mails notifying you when toner runs out or a paper misfeed occurs. See the Web Image Monitor Help.
- Using Web Image Monitor, you can receive information on the machine status via e-mail. See the Web Image Monitor Help.

Preventing an Unauthorized Copy

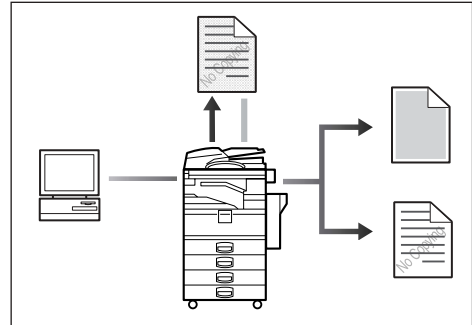

AHR0235

- Using the printer driver, you can embed a pattern in the printed document. If the document is copied on a machine with the Copy Data Security Unit(*), protected pages are grayed out in the copy, preventing confidential information from being copied. If the document is copied on a machine without the Copy Data Security Unit(*), the hidden text becomes conspicuous in the copy, showing that the copy is Unauthorized. See the printer driver Help. See *Printer Reference*.
- Using the printer driver, you can embed text in the printed document for unauthorized copy prevention. If the document is copied, scanned, or stored in a Document Server by a copier or multifunction printer, the embedded text appears conspicuous in the copy, discouraging such unauthorized copying. See the printer driver Help. See *Printer Reference*.
- If a document protected by unauthorized copy guard is copied on a machine that is equipped with the Copy Data Security Unit(*), the machine beeps to notify users that unauthorized copying is being attempted. See *Security Reference*.

TABLE OF CONTENTS

Manuals for This Machine	i
What You Can Do with This Machine	iii
Copier, Facsimile, Printer, and Scanner Functions	iii
Utilizing Stored Documents	iii
Paperless Fax Transmission and Reception	iv
Fax Transmission and Reception Through the Internet	iv
Using the Scanner in a Network Environment	v
Administrating the Machine/Protecting Documents (Security Functions)	v
Monitoring the Machine Via Computer	vi
Preventing an Unauthorized Copy	vi
Notice	1
Copyrights and Trademarks	2
Trademarks	2
Information about Installed Software	3
How to Read This Manual	9
Safety Information	10
Safety During Operation	10
Positions of Labels and Hallmarks for ⚠ WARNING and ⚠ CAUTION	12
ENERGY STAR Program	13
Machine Types	15

1. Getting Started

Guide to Components	17
External Options	19
Internal Options	20
Control Panel	21
Display Panel	23
When the Authentication Screen is displayed	24
Turning On the Power	25
Turning On the Main Power	25
Turning On the Power	25
Turning Off the Power	26
Turning Off the Main Power	26
Saving Energy	27

2. Combined Function Operations

Changing Modes	29
Multi-Access	31

3. Document Server

Relationship between Document Server and Other Functions	35
Document Server Display	36
Using the Document Server	37
Storing Data	37
Changing a Stored Document's File Name, User Name, or Password	40
Searching for Stored Documents	41
Printing Stored Documents	42
Deleting Stored Documents	45
Viewing Stored Documents Using a Web Image Monitor	46
Downloading Stored Documents	46
Settings for the Document Server	47

4. User Tools (System Settings)

User Tools Menu (System Settings)	49
Accessing User Tools (System Settings)	52
Changing Default Settings	52
Exiting User Tools	52
Settings You Can Change with User Tools	53
General Features	53
Tray Paper Settings	56
Timer Settings	59
Administrator Tools	62

5. Registering Addresses and Users for Facsimile/Scanner Functions

Address Book	69
Registering Names	72
Registering a Name	72
Changing a Registered Name	73
Deleting a Registered Name	73
Authentication Information	74
Registering a New User Code	74
Changing a User Code	75
Deleting a User Code	76
Displaying the Counter for Each User Code	76
Printing the Counter for Each User Code	76
Clearing the Number of Prints	77
Fax Destination	79
Registering a Fax Destination	80
Changing a Registered Fax Destination	82
Deleting a Registered Fax Destination	83
Registering an IP-Fax Destination	84
Changing a Registered IP-Fax Destination	85
Deleting a Registered IP-Fax Destination	86
E-mail Destination	88
Registering an E-mail Destination	88
Changing a Registered E-mail Destination	89
Deleting a Registered E-mail Destination	90

Registering Folders	91
Using SMB to Connect.....	91
Using FTP to Connect.....	95
Using NCP to Connect.....	98
Registering Names to a Group	102
Registering a New Group.....	102
Registering Names to a Group.....	103
Displaying Names Registered in Groups	103
Removing a Name from a Group	104
Changing a Group Name	104
Deleting a Group.....	105
Adding a Group to Another Group	105
Deleting a Group within a Group.....	105
Registering a Protection Code	107
Registering a Protection Code To a Single User	107
Registering a Protection Code To a Group User	108
Registering the Transfer Request	109
Registering a Transfer Station/Receiving Station	109
Changing a Registered Transfer Station/Receiving Station.....	111
Deleting a Registered Transfer Station/Receiving Station	112
Registering Authentication	113
SMTP Authentication	113
LDAP Authentication.....	114

6. Troubleshooting

If Your Machine Does Not Operate As You Want.....	117
General	117
Document Server	120
📄 Loading Paper	121
Loading Paper into Paper Trays	121
Loading Paper into Large Capacity Tray (optional).....	122
🖨 Adding Toner.....	124
Removing Toner.....	125
Inserting Toner.....	126
🔄 Clearing Misfeeds	127
Changing the Paper Size.....	132
Changing the Paper Size of the Paper Tray	132
📄 Adding Staples.....	135
500-Sheet Finisher.....	135
1000-Sheet Finisher.....	136
Removing Jammed Staples	138
500-Sheet Finisher.....	138
1000-Sheet Finisher.....	139
Replacing the Stamp Cartridge	140

7. Remarks

Dos and Don'ts	141
Toner	142
Handling Toner.....	142
Toner Storage	142
Used Toner	142
Where to Put Your Machine	143
Machine Environment	143
Moving.....	143
Power Connection.....	144
Access to the Machine	144
Maintaining Your Machine	145
Cleaning the Exposure Glass.....	145
Cleaning the Exposure Glass Cover	145
Cleaning the Auto Document Feeder.....	145
Other Functions	146
Inquiry	146
Changing the Display Language	146
Counter	147
Displaying the Total Counter.....	147

8. Entering Text

Entering Text	149
Available Characters	149
Keys	149
How to Enter Text	150

9. Specifications

Main Unit	151
Options	156
Exposure Glass Cover	156
Auto Document Feeder	156
500-Sheet Finisher	156
1000-Sheet Finisher	157
Shift Sort Tray	158
Duplex Unit.....	159
Bypass Tray	159
Bridge Unit	160
Internal Tray 2 (1 bin tray).....	160
Large Capacity Tray.....	160
Paper Tray Unit.....	161
Copy Paper	162
Recommended Paper Sizes and Types.....	162
Unusable Paper	165
Paper Storage	165
INDEX	166

Notice

Notice To Wireless LAN Interface (optional) Users



Notice to Users in EEA Countries

This product complies with the essential requirements and provisions of Directive 1999/5/EC of the European Parliament and of the Council of 9 March 1999 on radio equipment and telecommunications terminal equipment and the mutual recognition of their conformity.

The CE Declaration of Conformity is available on the Internet at URL:

http://www.ricoh.co.jp/fax/ce_doc/.

This product is only for use in EEA or other authorized countries. Outdoor use of this product in Belgium, France, Germany, Italy, or the Netherlands is prohibited.

Copyrights and Trademarks

Trademarks

Microsoft[®], Windows[®] and Windows NT[®] are registered trademarks of Microsoft Corporation in the United States and/or other countries.

Acrobat[®] is a registered trademark of Adobe Systems Incorporated.

The Bluetooth[®] word mark and logos are owned by the Bluetooth SIG, Inc. and any use of such marks by Ricoh Company, Ltd. is under license.

NetWare is a registered trademark of Novell, Inc.

Other product names used herein are for identification purposes only and might be trademarks of their respective companies. We disclaim any and all rights to those marks.

The proper names of the Windows operating systems are as follows:

- The product name of Windows[®] 95 is Microsoft[®] Windows[®] 95
- The product name of Windows[®] 98 is Microsoft[®] Windows[®] 98
- The product name of Windows[®] Me is Microsoft[®] Windows[®] Millennium Edition (Windows Me)
- The product names of Windows[®] 2000 are as follows:
Microsoft[®] Windows[®] 2000 Advanced Server
Microsoft[®] Windows[®] 2000 Server
Microsoft[®] Windows[®] 2000 Professional
- The product names of Windows[®] XP are as follows:
Microsoft[®] Windows[®] XP Professional
Microsoft[®] Windows[®] XP Home Edition
- The product names of Windows Server[™] 2003 are as follows:
Microsoft[®] Windows Server[™] 2003 Standard Edition
Microsoft[®] Windows Server[™] 2003 Enterprise Edition
Microsoft[®] Windows Server[™] 2003 Web Edition
- The product names of Windows[®] NT are as follows:
Microsoft[®] Windows NT[®] Server 4.0
Microsoft[®] Windows NT[®] Workstation 4.0

Information about Installed Software

expat

- The software including controller, etc. (hereinafter "software") installed on this product uses the expat under the conditions mentioned below.
- The product manufacturer provides warranty and support to the software of the product including the expat, and the product manufacturer makes the initial developer and copyright holder of the expat, free from these obligations.
- Information relating to the expat is available at:
<http://expat.sourceforge.net/>

Copyright © 1998, 1999, 2000 Thai Open Source Software Centre, Ltd. and Clark Cooper.

Copyright © 2001, 2002 Expat maintainers.

Permission is hereby granted, free of charge, to any person obtaining a copy of this software and associated documentation files (the "Software"), to deal in the Software without restriction, including without limitation the rights to use, copy, modify, merge, publish, distribute, sublicense, and/or sell copies of the Software, and to permit persons to whom the Software is furnished to do so, subject to the following conditions:

The above copyright notice and this permission notice shall be included in all copies or substantial portions of the Software.

THE SOFTWARE IS PROVIDED "AS IS", WITHOUT WARRANTY OF ANY KIND, EXPRESS OR IMPLIED, INCLUDING BUT NOT LIMITED TO THE WARRANTIES OF MERCHANTABILITY, FITNESS FOR A PARTICULAR PURPOSE AND NONINFRINGEMENT. IN NO EVENT SHALL THE AUTHORS OR COPYRIGHT HOLDERS BE LIABLE FOR ANY CLAIM, DAMAGES OR OTHER LIABILITY, WHETHER IN AN ACTION OF CONTRACT, TORT OR OTHERWISE, ARISING FROM, OUT OF OR IN CONNECTION WITH THE SOFTWARE OR THE USE OR OTHER DEALINGS IN THE SOFTWARE.

NetBSD

1. Copyright Notice of NetBSD

For all users to use this product:

This product contains NetBSD operating system:

For the most part, the software constituting the NetBSD operating system is not in the public domain; its authors retain their copyright.

The following text shows the copyright notice used for many of the NetBSD source code. For exact copyright notice applicable for each of the files/binaries, the source code tree must be consulted.

A full source code can be found at <http://www.netbsd.org/>.

Copyright © 1999, 2000 The NetBSD Foundation, Inc.

All rights reserved.

Redistribution and use in source and binary forms, with or without modification, are permitted provided that the following conditions are met:

- ① Redistributions of source code must retain the above copyright notice, this list of conditions and the following disclaimer.
- ② Redistributions in binary form must reproduce the above copyright notice, this list of conditions and the following disclaimer in the documentation and/or other materials provided with the distribution.
- ③ All advertising materials mentioning features or use of this software must display the following acknowledgment:
This product includes software developed by The NetBSD Foundation, Inc. and its contributors.
- ④ Neither the name of The NetBSD Foundation nor the names of its contributors may be used to endorse or promote products derived from this software without specific prior written permission.

THIS SOFTWARE IS PROVIDED BY THE NETBSD FOUNDATION, INC. AND CONTRIBUTORS "AS IS" AND ANY EXPRESS OR IMPLIED WARRANTIES, INCLUDING, BUT NOT LIMITED TO, THE IMPLIED WARRANTIES OF MERCHANTABILITY AND FITNESS FOR A PARTICULAR PURPOSE ARE DISCLAIMED. IN NO EVENT SHALL THE FOUNDATION OR CONTRIBUTORS BE LIABLE FOR ANY DIRECT, INDIRECT, INCIDENTAL, SPECIAL, EXEMPLARY, OR CONSEQUENTIAL DAMAGES (INCLUDING, BUT NOT LIMITED TO, PROCUREMENT OF SUBSTITUTE GOODS OR SERVICES; LOSS OF USE, DATA, OR PROFITS; OR BUSINESS INTERRUPTION) HOWEVER CAUSED AND ON ANY THEORY OF LIABILITY, WHETHER IN CONTRACT, STRICT LIABILITY, OR TORT (INCLUDING NEGLIGENCE OR OTHERWISE) ARISING IN ANY WAY OUT OF THE USE OF THIS SOFTWARE, EVEN IF ADVISED OF THE POSSIBILITY OF SUCH DAMAGE.

2. Authors Name List

All product names mentioned herein are trademarks of their respective owners. The following notices are required to satisfy the license terms of the software that we have mentioned in this document:

- This product includes software developed by the University of California, Berkeley and its contributors.
- This product includes software developed by Jonathan R. Stone for the NetBSD Project.
- This product includes software developed by the NetBSD Foundation, Inc. and its contributors.
- This product includes software developed by Manuel Bouyer.
- This product includes software developed by Charles Hannum.
- This product includes software developed by Charles M. Hannum.
- This product includes software developed by Christopher G. Demetriou.
- This product includes software developed by TooLs GmbH.
- This product includes software developed by Terrence R. Lambert.
- This product includes software developed by Adam Glass and Charles Hannum.
- This product includes software developed by Theo de Raadt.

- This product includes software developed by Jonathan Stone and Jason R. Thorpe for the NetBSD Project.
- This product includes software developed by the University of California, Lawrence Berkeley Laboratory and its contributors.
- This product includes software developed by Christos Zoulas.
- This product includes software developed by Christopher G. Demetriou for the NetBSD Project.
- This product includes software developed by Paul Kranenburg.
- This product includes software developed by Adam Glass.
- This product includes software developed by Jonathan Stone.
- This product includes software developed by Jonathan Stone for the NetBSD Project.
- This product includes software developed by Winning Strategies, Inc.
- This product includes software developed by Frank van der Linden for the NetBSD Project.
- This product includes software developed for the NetBSD Project by Frank van der Linden
- This product includes software developed for the NetBSD Project by Jason R. Thorpe.
- The software was developed by the University of California, Berkeley.
- This product includes software developed by Chris Provenzano, the University of California, Berkeley, and contributors.

Sablotron

Sablotron (Version 0.82) Copyright © 2000 Ginger Alliance Ltd. All Rights Reserved

- a) The application software installed on this product includes the Sablotron software Version 0.82 (hereinafter, "Sablotron 0.82"), with modifications made by the product manufacturer. The original code of the Sablotron 0.82 is provided by Ginger Alliance Ltd., the initial developer, and the modified code of the Sablotron 0.82 has been derived from such original code provided by Ginger Alliance Ltd.
- b) The product manufacturer provides warranty and support to the application software of this product including the Sablotron 0.82 as modified, and the product manufacturer makes Ginger Alliance Ltd., the initial developer of the Sablotron 0.82, free from these obligations.
- c) The Sablotron 0.82 and the modifications thereof are made available under the terms of Mozilla Public License Version 1.1 (hereinafter, "MPL 1.1"), and the application software of this product constitutes the "Larger Work" as defined in MPL 1.1. The application software of this product except for the Sablotron 0.82 as modified is licensed by the product manufacturer under separate agreement(s).
- d) The source code of the modified code of the Sablotron 0.82 is available at: <http://support-download.com/services/device/sablot/notice082.html>
- e) The source code of the Sablotron software is available at: <http://www.gingerall.com>
- f) MPL 1.1 is available at: <http://www.mozilla.org/MPL/MPL-1.1.html>

JPEG LIBRARY

- The software installed on this product is based in part on the work of the Independent JPEG Group.

SASL

CMU libsassl

Tim Martin

Rob Earhart

Rob Siemborski

Copyright © 2001 Carnegie Mellon University. All rights reserved.

Redistribution and use in source and binary forms, with or without modification, are permitted provided that the following conditions are met:

- ① Redistributions of source code must retain the above copyright notice, this list of conditions and the following disclaimer.
- ② Redistributions in binary form must reproduce the above copyright notice, this list of conditions and the following disclaimer in the documentation and/or other materials provided with the distribution.
- ③ The name "Carnegie Mellon University" must not be used to endorse or promote products derived from this software without prior written permission. For permission or any other legal details, please contact:

Office of Technology Transfer
Carnegie Mellon University
5000 Forbes Avenue
Pittsburgh, PA 15213-3890
(412) 268-4387, fax: (412) 268-7395
tech-transfer@andrew.cmu.edu

- ④ Redistributions of any form whatsoever must retain the following acknowledgment:

"This product includes software developed by Computing Services at Carnegie Mellon University (<http://www.cmu.edu/computing/>)."

CARNEGIE MELLON UNIVERSITY DISCLAIMS ALL WARRANTIES WITH REGARD TO THIS SOFTWARE, INCLUDING ALL IMPLIED WARRANTIES OF MERCHANTABILITY AND FITNESS, IN NO EVENT SHALL CARNEGIE MELLON UNIVERSITY BE LIABLE FOR ANY SPECIAL, INDIRECT OR CONSEQUENTIAL DAMAGES OR ANY DAMAGES WHATSOEVER RESULTING FROM LOSS OF USE, DATA OR PROFITS, WHETHER IN AN ACTION OF CONTRACT, NEGLIGENCE OR OTHER TORTIOUS ACTION, ARISING OUT OF OR IN CONNECTION WITH THE USE OR PERFORMANCE OF THIS SOFTWARE.

MD4

Copyright © 1990-2, RSA Data Security, Inc. All rights reserved.

License to copy and use this software is granted provided that it is identified as the "RSA Data Security, Inc. MD4 Message-Digest Algorithm" in all material mentioning or referencing this software or this function.

License is also granted to make and use derivative works provided that such works are identified as "derived from the RSA Data Security, Inc. MD4 Message-Digest Algorithm" in all material mentioning or referencing the derived work.

RSA Data Security, Inc. makes no representations concerning either the merchantability of this software or the suitability of this software for any particular purpose. It is provided "as is" without express or implied warranty of any kind.

These notices must be retained in any copies of any part of this documentation and/or software.

MD5

Copyright © 1991-2, RSA Data Security, Inc. Created 1991. All rights reserved.

License to copy and use this software is granted provided that it is identified as the "RSA Data Security, Inc. MD5 Message-Digest Algorithm" in all material mentioning or referencing this software or this function.

License is also granted to make and use derivative works provided that such works are identified as "derived from the RSA Data Security, Inc. MD5 Message-Digest Algorithm" in all material mentioning or referencing the derived work.

RSA Data Security, Inc. makes no representations concerning either the merchantability of this software or the suitability of this software for any particular purpose. It is provided "as is" without express or implied warranty of any kind.

These notices must be retained in any copies of any part of this documentation and/or software.

Samba(Ver 2.2.2-ja-1.1)

For SMB transmission, this machine uses Samba ver 2.2.2-ja-1.1 (hereinafter referred to as Samba 2.2.2-ja-1.1).

Copyright © Andrew Tridgell 1994-1998

This program is free software; you can redistribute it and/or modify it under the terms of the GNU General Public License as published by the Free Software Foundation; either version 2 of the License, or (at your option) any later version.

This program is distributed in the hope that it will be useful, but WITHOUT ANY WARRANTY; without even the implied warranty of MERCHANTABILITY or FITNESS FOR A PARTICULAR PURPOSE. See the GNU General Public License for more details.

You should have received a copy of the GNU General Public License along with this program; if not, write to the Free Software Foundation, Inc., 675 Mass Ave, Cambridge, MA 02139, USA

 **Note**

- The source code for SMB transmission by this machine can be downloaded from the following website:

<http://support-download.com/services/scbs>

RSA BSAFE®



- This product includes RSA BSAFE® cryptographic or security protocol software from RSA Security Inc.
- RSA and BSAFE are registered trademarks of RSA Security Inc. in the United States and/or other countries.
- RSA Security Inc. All rights reserved.

How to Read This Manual

Symbols

This manual uses the following symbols:

WARNING:

This symbol indicates a potentially hazardous situation that might result in death or serious injury if you misuse the machine by not following these instructions under this symbol. Be sure to read these instructions, all of which are included in the Safety Information section in the *General Settings Guide*.

CAUTION:

This symbol indicates a potentially hazardous situation that might result in minor or moderate injury or property damage not involving bodily injury, if you misuse the machine by not following these instructions under this symbol. Be sure to read the instructions, all of which are included in the Safety Information section in the *General Settings Guide*.

* The above statements are for your safety.

Important

If this instruction is not followed, paper might be misfed, originals damaged, or data lost. Be sure to read this.

Preparation

This symbol indicates the prior knowledge or preparation required before operation.

Note

This symbol indicates precautions for operation, or actions to take following mal-operation.

Limitation

This symbol indicates numerical limits, functions that cannot be used together, or conditions under which a particular function cannot be used.

Reference

This symbol indicates where further relevant information can be found.

[]

Keys that appear on the machine's display panel.

[]

Keys built into the machine's control panel.

Safety Information

When using this machine, the following safety precautions should always be followed.

Safety During Operation

In this manual, the following important symbols are used:

⚠ WARNING:
Indicates a potentially hazardous situation which, if instructions are not followed, could result in death or serious injury.

⚠ CAUTION:
Indicates a potentially hazardous situation which, if instructions are not followed, may result in minor or moderate injury or damage to property.

⚠ WARNING:

- **Connect the power cord directly into a wall outlet and do not use an extension cord.**
- **Disconnect the power plug (by pulling the plug, not the cable) if the power cable or plug becomes frayed or otherwise damaged.**
- **To avoid hazardous electric shock or laser radiation exposure, do not remove any covers or screws other than those specified in this manual.**
- **Turn off the power and disconnect the power plug (by pulling the plug, not the cable) if any of the following occurs:**
 - **You spill something into the machine.**
 - **You suspect that your machine needs service or repair.**
 - **The external housing of your machine has been damaged.**
- **Do not incinerate used toner or toner containers. Toner dust might ignite when exposed to an open flame.**
- **Disposal can take place at our authorized dealer.**
- **Dispose of used toner containers in accordance with local regulations.**
- **Keep the machine away from flammable liquids, gases, and aerosols. A fire or an electric shock might occur.**
- **Connect the machine only to the power source described on the inside front cover of this manual.**
- **Do not damage, break or make any modifications to the power cord. Do not place heavy objects on it. Do not pull it hard nor bend it more than necessary. These actions could cause an electric shock or fire.**
- **Do not incinerate the photoconductor unit. Toner dust might ignite when exposed to an open flame. Dispose of the used photoconductor unit in accordance with local regulations.**

⚠ CAUTION:

- *Protect the machine from dampness or wet weather, such as rain and snow.*
- *Unplug the power cord from the wall outlet before you move the machine. While moving the machine, you should take care that the power cord will not be damaged under the machine.*
- *When you disconnect the power plug from the wall outlet, always pull the plug (not the cable).*
- *Do not allow paper clips, staples, or other small metallic objects to fall inside the machine.*
- *Keep toner (used or unused) and toner containers out of reach of children.*
- *For environmental reasons, do not dispose of the machine or expended supply waste at household waste collection points. Disposal can take place at an authorized dealer.*
- *The inside of the machine could be very hot. Do not touch the parts with a label indicating the "hot surface". Otherwise, an injury might occur.*
- *If toner or used toner is inhaled, gargle with plenty of water and move into a fresh air environment. Consult a doctor if necessary.*
- *If toner or used toner gets into your eyes, flush immediately with large amounts of water. Consult a doctor if necessary.*
- *If toner or used toner is swallowed, dilute by drinking a large amount of water. Consult a doctor if necessary.*
- *Avoid getting toner on your clothes or skin when removing a paper jam or replacing toner. If your skin comes into contact with toner, wash the affected area thoroughly with soap and water.*
- *If toner gets on your clothing, wash with cold water. Hot water will set the toner into the fabric and may make removing the stain impossible.*
- *Keep the machine away from humidity and dust. Otherwise a fire or an electric shock might occur.*
- *Do not place the machine on an unstable or tilted surface. If it topples over, an injury might occur.*
- *If you use the machine in a confined space, make sure there is a continuous air turnover.*
- *The fusing section of this machine might be very hot. Caution should be taken when removing misfed paper.*
- *Do not use aluminum foil, carbon paper, or similar conductive paper to avoid a fire or machine failure.*

Positions of Labels and Hallmarks for ⚠️ WARNING and ⚠️ CAUTION

This machine has labels for ⚠️ WARNING and ⚠️ CAUTION at the positions shown below. For safety, please follow the instructions and handle the machine as indicated.

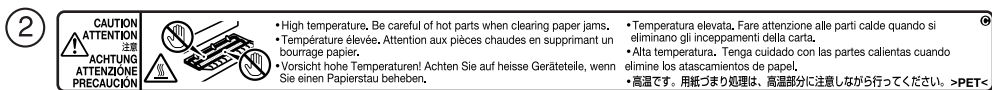
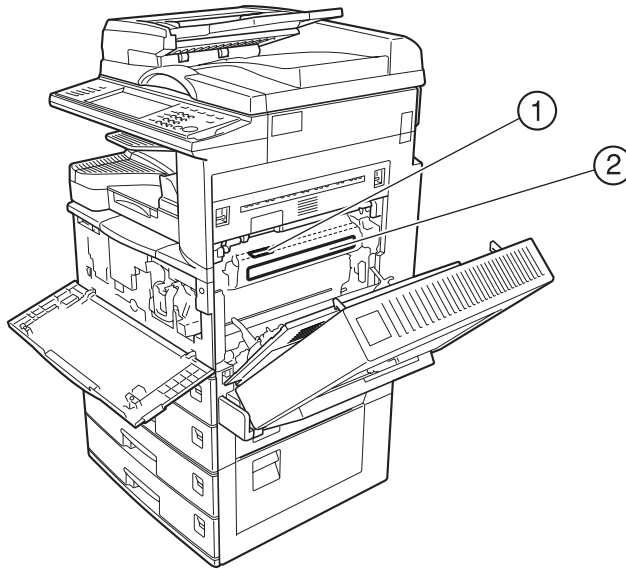

ZLEH010J

ENERGY STAR Program

<p>ENERGY STAR®</p> 	<p>As an ENERGY STAR Partner, we have determined that this machine model meets the ENERGY STAR Guidelines for energy efficiency.</p>
---	--

The ENERGY STAR Guidelines intend to establish an international energy-saving system for developing and introducing energy-efficient office equipment to deal with environmental issues, such as global warming.

When a product meets the ENERGY STAR Guidelines for energy efficiency, the Partner shall place the ENERGY STAR logo onto the machine model.

This product was designed to reduce the environmental impact associated with office equipment by means of energy-saving features, such as Low-power mode.

❖ Low-Power mode and Off mode or Sleep mode

This product automatically lowers its power consumption when it is not operated for a fixed time (standard setting time: 1 minute). This is called “Off mode” on a single function copying machine, and “Sleep mode” on a multiple function machine equipped with optional facsimile and printing functions.

- Off mode: Same as the condition when the operation switch is turned off.
- Sleep mode: Same as the condition when the operation switch is turned off. Receiving fax messages and printing from a computer are possible.

If you want to operate this product while it is in either of these modes, do one of the following:

- Turn on the operation switch.
- Place an original in the Auto Document Feeder (ADF).
- Lift and lower the exposure glass cover or the ADF.

The default interval before entering Off mode or Sleep mode can be adjusted. To change it, see p.59 “Auto Off Timer”.

The ENERGY STAR Program establishes two modes which lower the power consumption of the product when it is not operated for a fixed time. These modes are the Low-power mode and the Off mode or Sleep mode. This product has only one mode, the Off mode or Sleep mode. This mode meets the requirements of both the Low-power mode and Off mode or Sleep mode. In this manual, the Off mode is called the Auto Off mode.

❖ Duplex Priority

The ENERGY STAR Program recommends the duplex function. By conserving paper resources this function is less of a burden to the environment. For applicable machines, duplex function (one-sided originals→ two-sided copies) can be selected preferentially when the operation switch or the main power switch is turned on, the **【Energy Saver】** key is pressed, or the machine resets automatically.

Reference

To change the settings of the Duplex Priority mode, see “Duplex Mode Priority” in “General Features 2/4”, *Copy Reference*.

Specifications





Low- Power mode, Off Mode	Power consumption	1.2W
	Default interval	1 minute
	Recovery time	10 seconds or less
Duplex Priority	1 Sided→1 Sided	

❖ Recycled Paper

In accordance with the ENERGY STAR Program, we recommend use of environmentally friendly recycled paper. Please contact your sales representative for recommended paper.

Machine Types

This machine comes in two models which vary in copy speed. To ascertain which model you have, see the inside front cover.

	Type 1	Type 2
Copy speed	25 copies/minute (A4  , 8 ¹ / ₂ " × 11" )	30 copies/minute (A4  , 8 ¹ / ₂ " × 11" )

1. Getting Started

Guide to Components

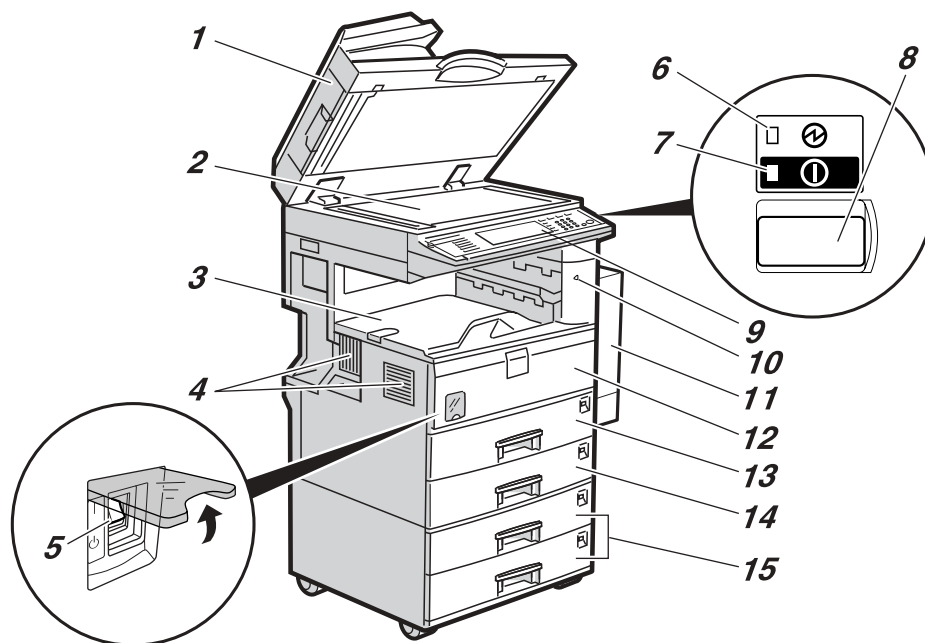

AHR007S

1. Exposure glass cover (optional) or Auto Document Feeder (ADF) (optional)

Lower the exposure glass cover over originals placed on the exposure glass. If you have the ADF, load a stack of originals here. They will be fed automatically, one by one.

(The illustration shows the ADF.)

2. Exposure glass

Place originals face down.

3. Internal tray

Copied, printed paper or fax messages are delivered here.

4. Ventilation holes

Prevents overheating. Do not obstruct the ventilation holes by placing anything near it or leaning objects against it. If the machine overheats, a fault might occur.

5. Main power switch

If the machine does not operate after turning on the operation switch, check the main power switch is turned on. If it is off, turn it on.

6. Main power indicator

This indicator lights when the main power switch is turned on, and goes off when the switch is turned off.

7. On indicator

This indicator lights when the operation switch is turned on, and goes off when the switch is turned off.

8. Operation switch

Press this switch to turn the power on (the **On** indicator lights up). To turn the power off, press this switch again (the **On** indicator goes off).

9. Control panel

See p.21 “Control Panel”.

10. Remove Paper Indicator

The indicator lights when paper is delivered to the internal tray 2 (1 bin tray). When paper is removed from the internal tray 2, the indicator goes off.

Note

- Internal tray 2 (1 bin tray) is optional.

11. Duplex unit (Unit for two-sided copies) (optional)

Makes two-sided copies.

See p.19 “External Options”

12. Front cover

Open to access the inside of the machine.

13. Paper tray

Load paper. See p.121 “ Loading Paper”.

14. Paper tray 2

Use when copying onto OHP transparencies, label paper (adhesive labels), translucent paper, postcards, envelopes and custom size paper. See p.121 “ Loading Paper”.

15. Paper tray unit (optional)

Load paper. See p.121 “ Loading Paper”, p.19 “External Options”.

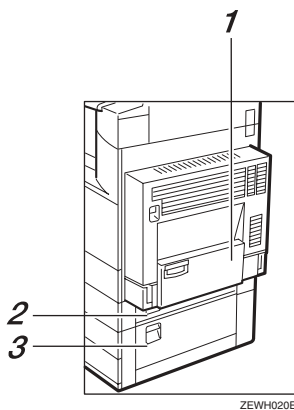
**1. Bypass tray (optional)**

See p.19 “External Options”

2. Paper tray cover

Open this cover to remove jammed paper.

3. Lower right cover

Open this cover to remove jammed paper.

External Options

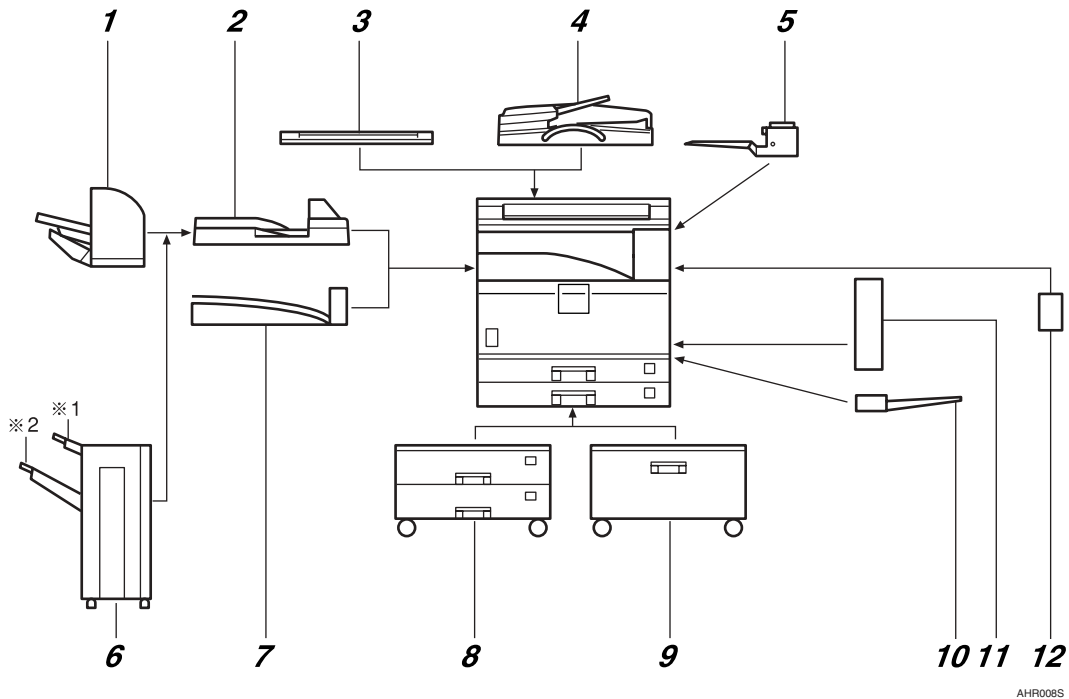

1. 500-sheet finisher

Sorts, stacks and staples copies.

Note

- You cannot install two finishers simultaneously.

2. Bridge unit

Relays copies to the finisher.

3. Exposure glass cover

Lower this cover over originals.

4. ADF

Load a stack of originals. They will feed in automatically.

5. Internal tray 2 (1 bin tray)

If you select this as the output tray, copies are delivered face down.

6. 1000-sheet finisher

Sorts, stacks and staples copies.

*1 : Finisher upper tray

*2 : Finisher shift tray

Note

- You cannot install two finishers simultaneously.

7. Shift sort tray

Sorts and stacks copies.

8. Paper tray unit

Consists of two paper trays.

9. Large Capacity Tray (LCT)

Holds up to 2000 sheets of paper.

10. Bypass tray

Use when copying onto OHP transparencies, label paper (adhesive labels), translucent paper, postcards, envelopes and custom size paper. See "Copying from the Bypass tray", *Copy Reference*.

11. Duplex unit

Use to make two-sided copies.

12. Inter change unit

Required when installing the internal tray 2 (1 bin tray) and duplex unit.

Internal Options

1

- ① HDD
Allows you to use the Document Server function.
 - ② Fax unit
Allows you to use the facsimile function.
 - ③ Printer/Scanner unit ^{*1}
Allows you to use the printer and scanner functions.
 - ④ IEEE 1394 interface board ^{*2}
Connects to an IEEE 1394 cable.
 - ⑤ Bluetooth ^{*2}
Allows you to expand the interface.
 - ⑥ File Format Converter ^{*2}
Allows you to download documents from the Document Server stored by copier and printer functions. See p.46 “Downloading Stored Documents”.
 - ⑦ IEEE 802.11b Wireless LAN Board ^{*2}
You can install a wireless LAN interface.
 - ⑧ IEEE 1284 Interface Board ^{*2}
Connects to an IEEE 1284 cable.
 - ⑨ User account enhance unit
Allows you to increase the number of user codes.
 - ⑩ Copy Data Security Unit
If a document containing embedded text for unauthorized copy guard is copied, protected pages are grayed out in the copy.
 - ⑪ DataOverWriteSecurity Unit
Allows you to erase data on the hard disk.
- ^{*1} The HDD is included.
- ^{*2} You cannot install two or more of the options below:
IEEE 1394 interface board, IEEE 802.11b wireless LAN board, IEEE 1284 Interface Board, Bluetooth, file format converter.
- ^{*3} If the Copy Data Security Unit is installed in the machine ,you can not use the scanner and fax functions.

Control Panel

This illustration shows the control panel of a machine that has all options fully installed.

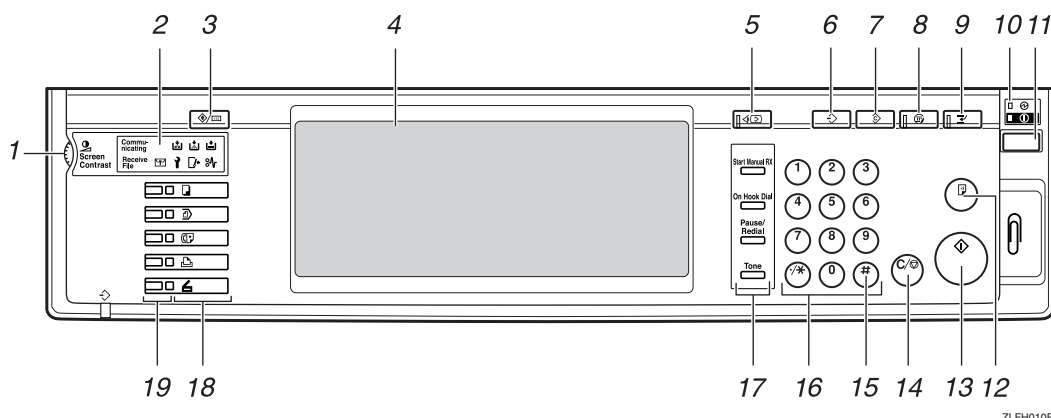

ZLFH010E

1. Screen contrast knob

Adjusts display panel brightness.

2. Indicators

Show errors and machine status.

- : Add Staple indicator. See p.135 "Adding Staples".
- : Add Toner indicator. See p.124 "Adding Toner".
- : Load Paper indicator. See p.121 "Loading Paper".
- : Service Call indicator
- : Open Cover indicator
- : Misfeed indicator. See p.127 "Clearing Misfeeds".
- : Data In indicator. See "Control Panel", *Printer Reference*.
- Communicating: Communicating indicator. See "Control Panel", *Facsimile Reference <Basic Features>*.
- : Confidential File indicator. See "Control Panel", *Facsimile Reference <Basic Features>*.
- Receiving File: Receiving File indicator. See "Control Panel", *Facsimile Reference <Basic Features>*.

3. [User Tools/Counter] key

- User Tools
Press to change defaults and conditions to meet your requirements. See p.52 "Accessing User Tools (System Settings)".
- Counter
Press to check or print the counter value. See p.147 "Counter".
- Inquiry
Press to check where to contact for machine repairs and ordering toner. See p.146 "Inquiry"

4. Display panel

Displays operation status, error messages, and function menus.

5. [Check Modes] key

Press to check settings.

6. [Program] key (copier/facsimile/scanner mode)

Press to register frequently used settings, or recall registered settings.

7. [Clear Modes] key

Press to clear previous copy job settings.

8. [Energy Saver] key

Press to switch to and from Energy Saver mode. See p.27 "Energy Saver Mode".

9. [Interrupt] key (copier/scanner mode)

Press to make interrupt copies during copying or scanning. See “Interrupt Copy”, *Copy Reference*.

10. Main power indicator and On indicator

The main power indicator goes on when you turn on the main power switch.

The On indicator lights when the power is on.

Important

- ❑ Do not turn off the main power switch while the power indicator is lit or blinking. Doing so may damage the hard disk.

11. Operation switch

Press to turn the power on (the **On** indicator goes on). To turn the power off, press again (the **On** indicator goes off).

12. [Sample Copy] key

Press to make a single set of copies or prints to check print quality before making multiple sets.

13. [Start] key

Press to start copying. Start scanning or printing documents stored using the Document Server function.

14. [Clear/Stop] key

- Clear
Press to delete a number entered.
- Stop
Press to stop a job in progress, such as scanning, faxing, or printing.

15. [#] key

Press to enter after a numerical value.

16. Number keys

Use to enter the numbers for copies, fax numbers and data for the selected function.





17. [Start Manual RX] key, [On Hook Dial] key, [Pause/Redial] key, and [Tone] key

Reference

Facsimile Reference <Basic Features>
and *Facsimile Reference <Advanced Features>*

18. Function keys

Press to select one of the following functions:

- Copy: 
- Document Server: 
- Facsimile: 
- Printer: 
- Scanner: 

19. Function status indicators.



These show the status of the above functions:

- Yellow: selected.
- Green: active.
- Red: interrupted.

Display Panel

The display panel shows machine status, error messages, and function menus.

The function items displayed serve as selector keys. You can select or specify an item by lightly pressing them.

When you select or specify an item on the display panel, it is highlighted thus . Keys appearing as  cannot be used.

Important

- A force or impact of more than 30 N (about 3 kgf) will damage the display panel.

The copying screen is displayed as default after power on.

The following display shows a machine with options fully installed.

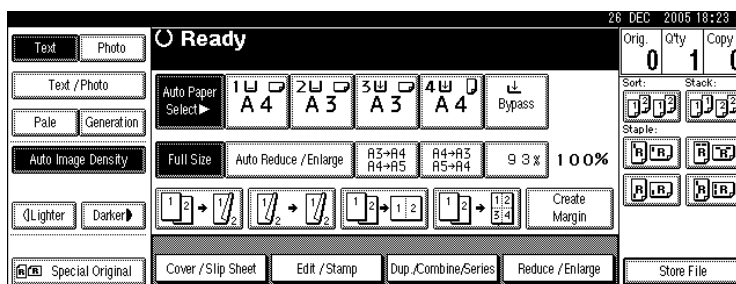

Common key operations

The following keys are common to all screens:

❖ Key list

[OK]	Acknowledges a selected function or entered values, and then returns to the previous display.
[Cancel]	Deletes a selected function or entered values, and then returns to the previous display.
[▲Prev.] [▼Next]	Moves to the previous or next display when all items cannot be shown on the same display.
[OK] [Yes]	Closes displayed messages.
[Clear]	Cancels entered values but does not change the settings.
[Exit]	Returns to the previous display.

When the Authentication Screen is displayed

When Basic Authentication, Windows Authentication, LDAP Authentication, or Integration Server Authentication is set, the authentication screen is displayed. Unless a valid user name and password are entered, operations are not possible with the machine.

Note

- ❑ Consult the User Administrator about your login user name and login password. For details of the various types of user authentication, consult the respective administrators.
- ❑ When User Code Authentication is set, the screen for entering a user code is displayed instead. For details, see .p.74 “Authentication Information”

1 Press [Enter] for Login User Name.

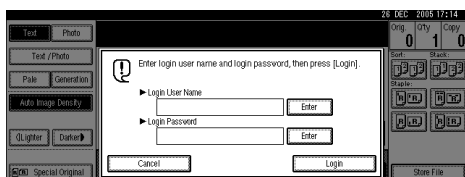

2 Enter a login user name, and then press [OK].

3 Press [Enter] for Login Password.

4 Enter a login password, and then press [OK].

5 Press [Login].

When the user is authenticated, the screen for the function you are using appears.

Note

- ❑ When the entered login user name or login password is not correct, "Authentication has failed." appears. Check the login user name and password.

Log Off

Important

- ❑ To prevent unauthorized users from using the machine, always log off when you have finished using the machine.

1 Press [User Tools / Counter].

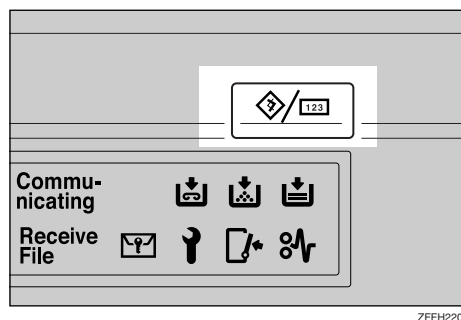

ZFFH220E

2 Press [Logout].

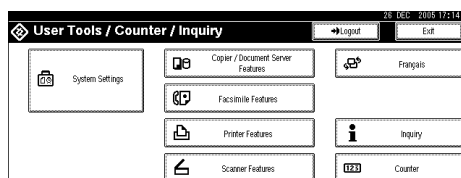

3 Press [Yes].

4 Press [User Tools / Counter].

Turning On the Power

This machine has two power switches.

❖ **Operation switch (right side of the control panel)**

Press to activate the machine. When the machine has finished warming up, you can make copies.

❖ **Main power switch (left side of the machine)**

Turning off this switch makes the main power indicator on the right side of the control panel go off. When this is done, machine power is completely off.

When the fax unit (optional) is installed, fax files in memory may be lost if you turn this switch off. Use this switch only when necessary.

 **Note**

- ❑ This machine automatically enters Energy Saver mode or turns itself off if you do not use it for a while. See p.59 “Auto Off Timer”.

Turning On the Main Power

- 1** Make sure that the power cord is firmly plugged into the wall outlet.

- 2** Open the switch cover, and then turn on the main power switch.

The main power indicator goes on.

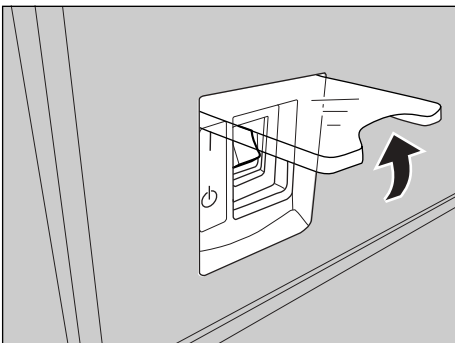

ZEWH040E

 **Important**

- ❑ Do not turn off the main power switch immediately after turning it on. Doing so may result in damage to the hard disk or memory, leading to malfunctions.

Turning On the Power

- 1** Press the operation switch.

The **On** indicator goes on.

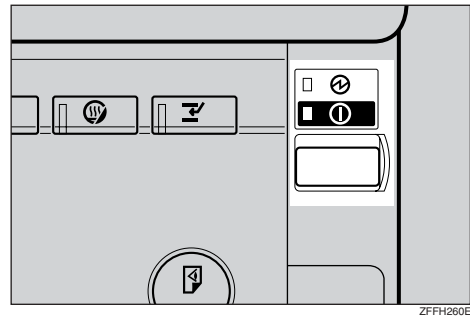

ZFFH260E

 **Note**

- ❑ If the power does not come on when the operation switch is pressed, check the main power switch is on. If it is off, turn it on.

Turning Off the Power

1 Make sure the exposure glass cover or the ADF is in the right position.

2 Press the operation switch.

The **On** indicator goes out.

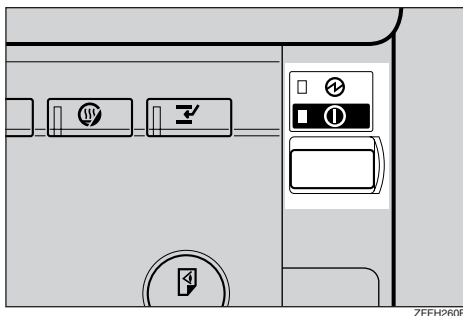

Note

- Even if you press the operation switch, the indicator does not go out, the blinks in the following cases:
 - When the exposure glass cover or ADF is open.
 - During communication with external equipment.
 - When the hard disk is active.
 - If a file is waiting to be transmitted within the next minute using the "Send Later" facsimile function.

Turning Off the Main Power

Important

- Do not turn off the main power switch when the **On** indicator is lit or blinking. Doing so may result in damage to the hard disk or memory.

- Be sure to turn off the main power switch before pulling out the power plug. Not doing this may result in damage to the hard disk or memory.

1 Make sure the **On** indicator is not lit.

2 Open the switch cover, and then turn off the main power switch.

The main power indicator goes out.

When the fax unit (optional) is installed

When the main power switch is turned off while using the facsimile function, waiting fax and print jobs may be canceled, and incoming fax documents not received. If you have to turn off this switch for some reason, follow the procedure below.

Important

- Make sure 100% is shown as available memory on the display before turning off the main power switch or unplugging the power cord. Fax files in memory are deleted an hour after you turn off the main power switch or unplug the power cord. See "Turning Off the Main Power/In the Event of Power Failure", *Facsimile Reference <Advanced Features>*.
- The **On** indicator does not go out, but blinks in dial-in mode even if you press the operation switch. When this happens, check the explanations below, and turn off the main power switch.
 - The computer is not controlling the machine.
 - The machine is not receiving a fax.

Saving Energy

Energy Saver Mode

If you do not use the machine for a certain period after an operation, or when you press the **[Energy Saver]** key, the display disappears and the machine goes into Energy Saver mode. When you press the **[Energy Saver]** key again, the machine returns to the ready condition. The machine uses less electricity in Energy Saver mode.

Note

- You can change the amount of time the machine waits before switching to Energy Saver mode after copying has finished or the last operation is performed. See p.60 "Panel Off Timer".

Auto Off

The machine automatically turns itself off when the job is finished, after a certain period of time has elapsed. This function is called "Auto Off".

Note

- You can change the Auto Off time. See p.59 "Auto Off Timer".
- The Auto Off Timer function will not operate in the following cases:
 - When a warning message appears
 - When the service call message appears
 - When paper is jammed
 - When the cover is open
 - When the "Add Toner" message appears
 - When toner is being replenished
 - When the User Tools/Counter screen is displayed
 - When fixed warm-up is in progress
 - When the facsimile, printer, or other functions are active
 - When operations were suspended during printing
 - When the handset is in use
 - When the On-hook dialing function is in use
 - When a recipient is being registered in the address list or group dial list
 - When the Data In indicator is on or blinking
 - When the screen of stored document under the printer function is displayed

2. Combined Function Operations

Changing Modes

Note

You cannot switch modes in any of the following situations:

- When scanning in a fax message for transmission
- During immediate transmission
- When accessing User Tools
- During interrupt copying
- During On hook dialing for fax transmission
- While scanning an original

The copying screen is displayed as default after power on. You can change this default setting. See p.53 "Function Priority".

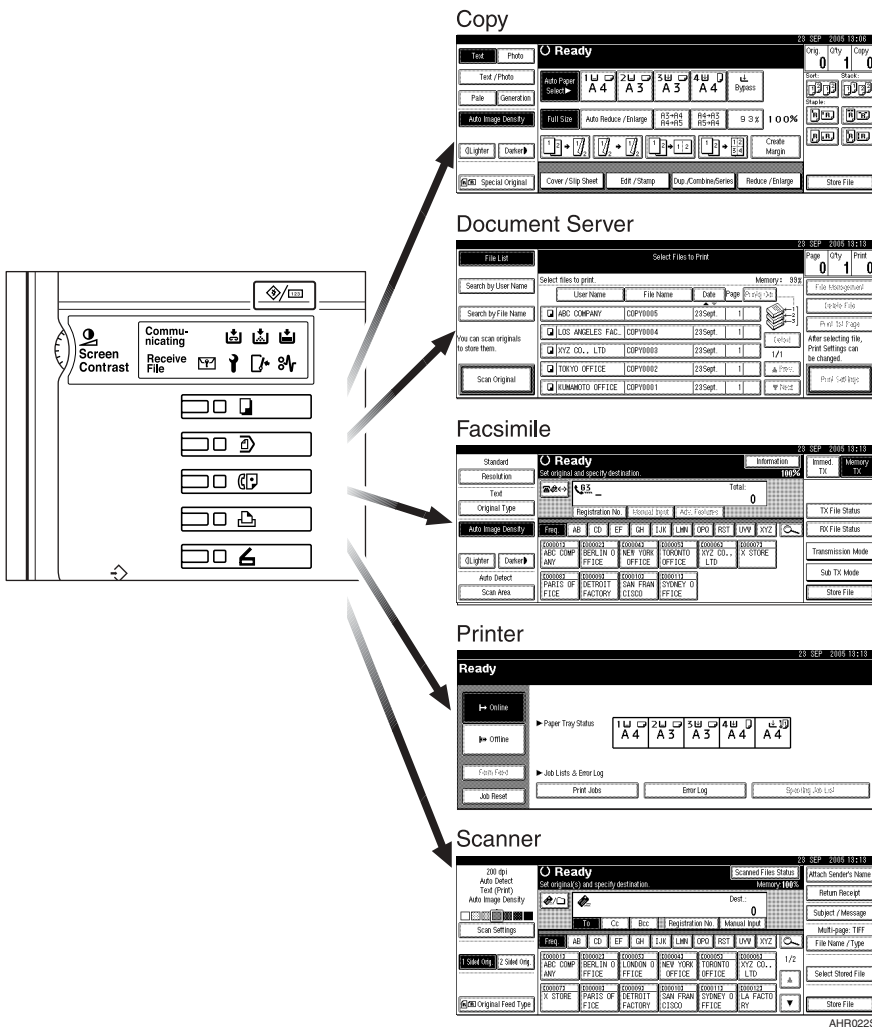

 **System Reset**

The machine returns automatically to its initial condition when the job is finished, after a certain period of time has elapsed. This function is called "System Reset".

 **Note**

- You can change the System Reset time. See p.60 "System Auto Reset Timer".
- 

Multi-Access

You can carry out another job using a different function while the current job is being performed. Performing multiple functions simultaneously like this is called "Multi-accessing".

This allows you to handle jobs efficiently, regardless of how the machine is being used. For example:

- While making copies, you can scan documents to store in the Document Server.
- While printing documents stored in the Document Server, the machine can receive print data.
- You can make copies while receiving fax data.
- While printing print data, you can make operations for copying.

Note

- ❑ See p.53 "Print Priority" for setting function priority. As default, **[Display Mode]** is set to first priority.
- ❑ When the Internal Tray 2 (1 bin tray), Shift Sort Tray, 500-sheet finisher, or 1000-sheet finisher is installed on the machine, you can specify the output tray where documents are delivered. For details about how to specify the output tray for each function, see the following descriptions:
 - p.54 "Output: Copier (copier)"
 - p.55 "Output: Document Server (Document Server)"
 - p.55 "Output: Facsimile (facsimile)"
 - p.55 "Output: Printer (printer)"

Function Compatibility

The chart shows Function Compatibility when print priority is set to "Interleave". See p.53 "Print Priority".

△: Simultaneous operations are possible.

●: Operation is enabled when the relevant function key is pressed and remote switching (of the scanner) is done.

○: Operation is enabled when the **[Interrupt]** key is pressed to interrupt the preceding operation.

→: Operation is performed automatically once the preceding operation ends.

×: The operation must be started once the preceding operation ends. (Simultaneous operations are not possible.)

Mode after you select		Copy			Interrupt Copying			Facsimile				Printer		Scanner		Document Server		DeskTopBinder Professional/Lite		Web-Document Server			
		Operations for Copying	Stapling	Sort	Operations for Copying	Copying	Transmission Operation	Scanning an Original for Memory Transmission	Memory Transmission	Immediate Transmission	Memory Reception	Printing Received Data	Data Reception	Print	Scanner	Document Server	Document Server	Scanning a Document to Store in Document Server	Printing from Document Server	Printing from Document Server	Sending a Facsimile from Document Server	Printing	
Mode before you select		Operations for Copying	Stapling	Sort	Operations for Copying	Copying	Transmission Operation	Scanning an Original for Memory Transmission	Memory Transmission	Immediate Transmission	Memory Reception	Printing Received Data	Data Reception	Print	Scanner	Document Server	Document Server	Scanning a Document to Store in Document Server	Printing from Document Server	Printing from Document Server	Sending a Facsimile from Document Server	Printing	
Copy	Operations for Copying	×	×	×	○	○	●	●	△	●	△	△	△	△	●	●	●	●	●	△	△	△	
	Stapling	△ *1	→ *1	→ *1	○	○	●	●	△	●	△	△	△	△	→	●	●	●	●	→	△	△	△
	Sort	△ *1	→ *1	→ *1	○	○	●	●	△	●	△	△	△	△	△	●	●	●	●	→	△	△	△
Interrupt Copying	Operations for Copying	○	○	○	×	×	×	×	△	×	△	△	△	△	△	×	×	×	×	×	△	△	△
	Copying	○	○	○	×	×	×	×	△	×	△	→	△	→	→	×	×	×	×	×	→	△	→
Facsimile	Transmission Operation/Manual Reception Operation	●	●	●	○	○	×	×	△	×	△	△	△	△	△	●	●	●	●	●	△	△	△
	Transmission	Scanning an original for Memory Transmission	×	×	×	×	×	×	△	×	△	△	△	△	△	×	×	×	×	×	△	△	△
		Memory Transmission	△	△	△	△	△	△	△	△	△	△	△	△	△	△	△	△	△	△	△	→	△
		Immediate Transmission	×	×	×	×	×	×	△	×	△	△	△	△	△	×	×	×	×	×	△	→	△
	Reception	Memory Reception	△	△	△	△	△	△	△	△	△	△	△	△	△	△	△	△	△	△	△	→	△
		Printing Received Data	△	△	△	△	△	△	△	△	△	×	△	△	△	△	△	△	△	△	△	→	△
Printer	Data Reception	△	△	△	△	△	△	△	△	△	△	△	→	→	→	△	△	△	△	△	△	△	△
	Print	Sort Print	△	△	△	○	○	△	△	△	△	△	△	△	→	→	△	△	△	△	△	△	△
		Stapling	△	→	△	○	○	△	△	△	△	△	△	△	→	→	△	△	△	△	△	△	△

Mode after you select		Copy			Interrupt Copying			Facsimile					Printer		Scanner		Document Server		DeskTopBinder Professional/Lite		Web-Document Server		
		Operations for Copying	Stapling	Sort	Operations for Copying	Copying	Transmission Operation	Scanning an Original for Memory Transmission	Memory Transmission	Immediate Transmission	Memory Reception	Printing Received Data	Data Reception	Printing	Stapling	Operations for Scanning	Scanning	Operations for Document Server	Scanning a Document to Store in Document Server	Printing from Document Server	Printing from Document Server	Sending a Facsimile from Document Server	Printing
Mode before you select		●	●	●	○	○	●	●	△	●	△	△	△	△	△	△	△	△	△	△	△	△	△
Scanner	Operations for scanning	●	●	●	○	○	●	●	△	●	△	△	△	△	△	△	△	△	△	△	△	△	△
	Scanning	×	×	×	×	×	×	△	×	△	△	△	△	△	△	△	×	×	×	×	△	△	△
Document Server	Operations for Document Server	●	●	●	○	○	●	●	△	●	△	△	△	△	△	△	●	●	×	×	×	×	△
	Scanning a Document to Store in Document Server	●	×	×	○	○	●	×	△	×	△	△	△	△	△	△	●	×	×	×	×	△	△
	Printing from Document Server	●	→	→	○	○	△	△	△	△	△	△	△	△	△	△	△	△	△	△	△	△	△
DeskTopBinder Professional/Lite	Printing from Document Server	△	△	△	△	△	△	△	△	△	△	△	△	△	△	△	△	△	△	△	△	→	△
	Sending a Facsimile from Document Server	△	△	△	△	△	△	△	△	△	△	△	△	△	△	△	△	△	△	△	△	→	△
WebDocument Server	Printing	△	△	△	△	△	△	△	△	△	△	△	△	△	△	△	△	△	△	△	△	△	→

*1 Simultaneous operations are only possible after the preceding job documents are all scanned and the **[NextJob]** key appears.

*2 You can scan a document after the preceding job documents are all scanned.

*3 When multiple lines are available, select a line which is currently not in use. Otherwise, operation will not be possible.

*4 During stapling, printing automatically starts after the current job.

*5 Stapling is not available.

*6 Simultaneous operations become possible after you press the **[NextJob]** key.

*7 During parallel receptions, any subsequent job is suspended until the receptions are completed.

 **Limitation**

- Stapling cannot be used at the same time for multiple functions.

 **Note**

- A machine with the 500-sheet finisher installed cannot accept other jobs while printing with the stapling operation.
- A machine with the 1000-sheet finisher installed, that is printing with the stapling operation on paper larger than A4 size, starts the subsequent job (for which Shift Sort Tray is specified as the output tray) only after the current print job finishes.
- While printing is in progress, scanning using another function may take more time.



3. Document Server

Relationship between Document Server and Other Functions

The following table describes the relationship between the Document Server and other functions.

function	Where to store documents	Displaying a list	Printing stored documents	Sending documents
Copy	Copy/Document Server	Available	Available	Not Available
Printer	Document Server	Available	Available	Not Available
Facsimile	Facsimile	Available	Available	Available ^{*1}
Scanner	Scanner	Not Available ^{*2}	Not Available	Available ^{*3}

^{*1} You can send stored documents using the facsimile function. See “Sending a Stored File”, *Facsimile Reference <Advanced Features>*.

^{*2} You can display stored documents using the scanner function. See *Scanner Reference*.

^{*3} You can send stored documents using the scanner function. See *Scanner Reference*.

Note

The following table shows the capacity of the Document Server.

	Number of pages for each file	Number of files	Number of pages in total
Copy	1,000 pages	3,000 files	9,000 pages
Printer			
Scanner			
Facsimile			

Document Server Display

❖ Document Server Main Display

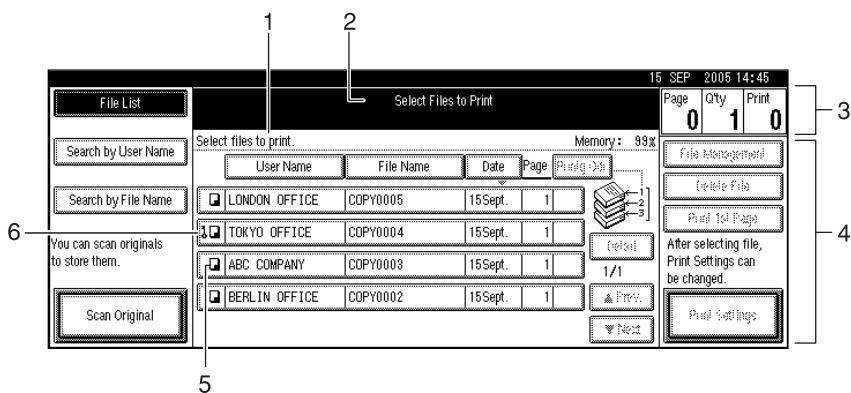

AHT028S

1. Operating status and messages.

2. The title of the currently selected screen.

3. The numbers of originals, copies, and printed pages.

4. The operation keys.

5. The functions under which the documents were stored.

6. A lock icon appears next to each password-protected file.

The icons below show the functions active when the documents were stored in the Document Server.

Function	Copier	Facsimile	Printer	Scanner
Icon				--

Note

- ❑ Depending on the settings of security functions, not all the stored documents may be displayed.

Using the Document Server

Storing Data

❖ File name

Stored documents are automatically named "COPY0001", "COPY0002". You can change assigned file names.

❖ User name

You can register a user name to identify the user or user group that stored the documents. To assign it, you can register the user name using the name assigned to the user code, or by entering the name directly.

Reference

For details about user name, see p.72 "Registering Names".

❖ Password

To prevent unauthorized printing, you can set a password for any stored file. A protected file can only be accessed by entering its password. When a password is set for the documents,  appears next to the documents.

Reference

To store documents without using Document Server function, see the manuals for those modes.

Important

- ❑ Data stored in the machine might be lost if some kind of failure occurs. The manufacture shall not be responsible for any damage resulting from loss of data.

- ❑ Be careful not to let anyone know your password, especially when entering a password or recording it. Keep any record of your password in a secure place.

- ❑ Avoid using a single number or consecutive numbers for a password such as "0000" or "1234", since the numbers like this are easy to guess, so using them will not provide a worthwhile level of security.

- ❑ A document accessed with a correct password remains selected even after operations are complete, and it can be accessed by other users. To stop this, be sure to press the **[Clear Modes]** key to cancel the document selection.

- ❑ The user name used when adding a document to the Document Server is to identify the document creator and type. It is not to protect confidential documents from others.

Note

- ❑ Enter a four-to eight-digit password.
- ❑ By default, data stored in the Document Server is deleted after three days (72 hours). You can specify the time taken for the stored data to be deleted automatically. See p.67 "Auto Delete File in Document Server".

- ❑ If you do not want stored data to be automatically deleted, select **[No]** in Auto Delete File before storing a document. If you select **[Yes]** later, data stored after will be automatically deleted.

- When the machine is printing a document stored using the copier function, wait until printing has finished before you store a document in the Document Server.

1 Press the **[Document Server]** key.

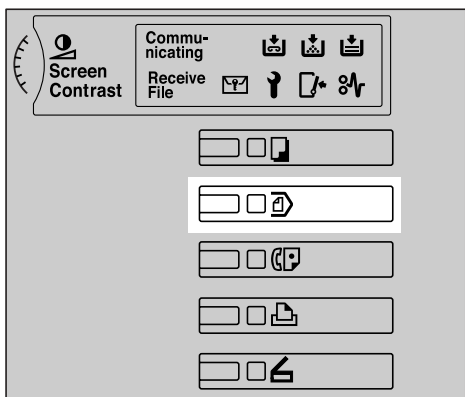

ZFFH240E

2 Press **[Scan Original]**.

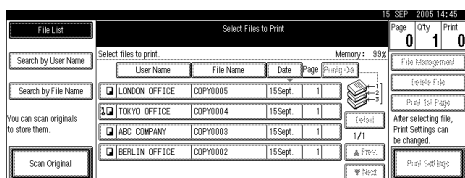

3 Enter a user name, file name, or password if necessary.

Note

- If you do not enter a file name, one is automatically assigned.

Reference

- p.39 "To register or change a user name"
- p.39 "To change a file name"
- p.40 "To set or change a password"

4 Place originals either on the exposure glass or in the ADF.

Reference

For information about types of originals and how to place them, see *Copy Reference*.

5 Make any required settings.

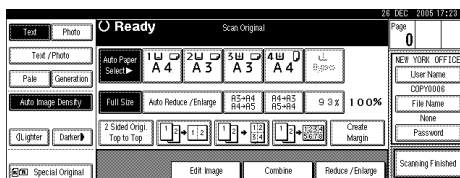

Reference

For details, see *Copy Reference*.

6 Press the **[Start]** key.

The document is stored in the Document Server.

Note

- To stop scanning, press the **[Clear/Stop]** key. To restart a paused scanning job, press **[Continue]** in the confirmation display. To delete saved images and cancel the job, press the **[Stop]** key.
- When a password is set, **1** appears on the left side of the file name.
- If you placed originals on the exposure glass, press **[Scanning Finished]** after all the originals have been scanned. The Select Files to Print display appears.

To register or change a user name

1 Press [Scan Original].

The Scan Original display appears.

2 Press [User Name].

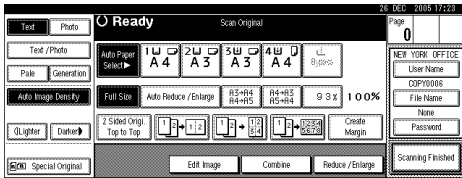

If user names are already registered, the Change User Name display appears. To use an unregistered user name, press [Non-programmed Name].

When no user name are registered in the Address Book, the User Name entry display appears.

Reference

p.74 "Authentication Information"

When using a registered user name in the Address Book

1 Select a registered user name from the list, and then press [OK].

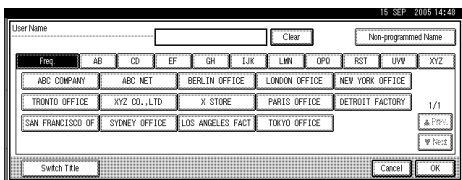

To change your user name to an unregistered user name, proceed to the next step.

Reference

p.74 "Registering a New User Code"

When using an unregistered user name in the Address Book

1 To enter an unregistered user name, press [Non-programmed Name].

2 Enter a new user name, and then press [OK].

Reference

p.149 "Entering Text"

When no user name has been registered in the Address Book

1 Enter a new user name, and then press [OK].

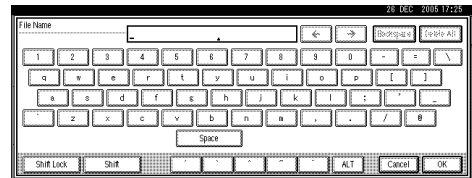

Reference

p.149 "Entering Text"

To change a file name

1 Press [Scan Original].

The Scan Original display appears.

2 Press [File Name].

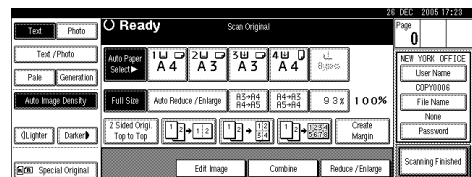

The Change File Name display appears.

3 Press [Delete All] to delete the old file name.

Note

You can also use [Backspace] to delete unnecessary characters.

- 4 Enter a new file name, and then press [OK].

 **Note**

- Up to 20 characters can be entered as a file name. Note that only 16 characters of each file name appear in the document list.

 **Reference**

p.149 "Entering Text"

3

To set or change a password

- 1 Press [Scan Original].

The Scan Original display appears.

- 2 Press [Password].

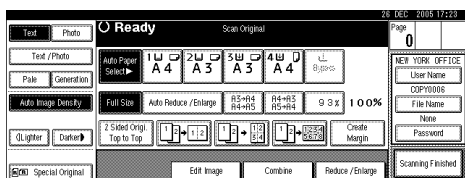

- 3 Enter a password using the number keys (four-to eight-digits), and then press the [#] key.

- 4 Reenter the password (four digits) for verification, and then press the [#] key.

- 5 Press [OK].

Changing a Stored Document's File Name, User Name, or Password

- 1 Press the [Document Server] key.

- 2 Select the document with the user name, file name, or password you want to change.

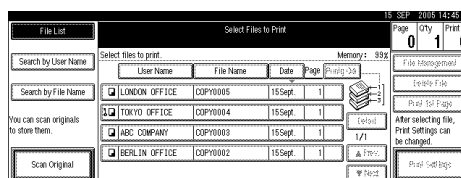

 **Note**

- If a password is already set for the document, enter that password, and then press [OK].

- 3 Press [File Management].

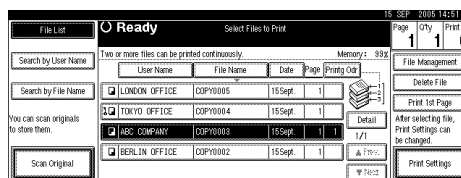

- 4 Press [Change User Name], [Change File Name], or [Change Password].

- 5 Enter the new user name, file name, or password using the letter keys or number keys, and then press [OK].

 **Reference**

p.39 "To register or change a user name"

p.39 "To change a file name"

p.40 "To set or change a password"

- 6 Press [OK].

Searching for Stored Documents

You can use either **[Search by File Name]** or **[Search by User Name]** to search for documents stored in the Document Server. You can also list stored documents in a preferred order.

Note

- ❑ If you install DeskTopBinder Professional or DeskTopBinder Lite on your computer, you can search for and rearrange documents using your computer.

Reference

Manuals for DeskTopBinder Professional/Lite or Help

To search by file name

- 1 Press the **[Document Server]** key.
- 2 Press **[Search by File Name]**.

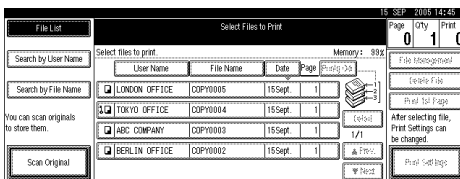

- 3 Enter the file name using the letter keys, and then press **[OK]**.

Only files beginning with the name entered appear in the Select Files to Print display.

Reference

p.149 "Entering Text".

Note

- ❑ To display all files stored in the Document Server, press **[File List]**.

To search by user name

- 1 Press the **[Document Server]** key.
- 2 Press **[Search by User Name]**.

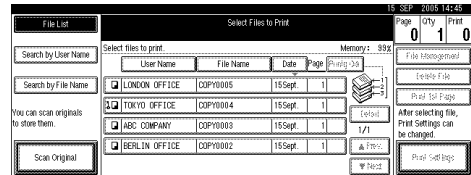

- 3 To specify a registered user name, select the user name from the displayed list, and then press **[OK]**.

Note

- ❑ To specify an unregistered user name, follow the procedure below.

- 4 To specify an unregistered user name, press **[Non-programmed Name]**. Enter a user name, and then press **[OK]**.

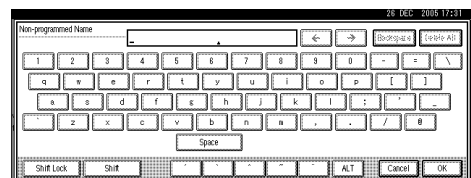

Reference

p.149 "Entering Text"

- 5 Press **[OK]**.

Only files beginning with the name entered appear in the Select Files to Print display.

Note

- ❑ To display all files stored in the Document Server, press **[File List]**.

Checking the Details of Stored Documents

- 1 Select a document to display its detailed information.

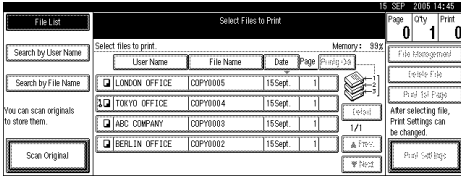

Note

- If a password is already set for the document, enter that password, and then press **[OK]**.

- 2 Press **[Detail]**.

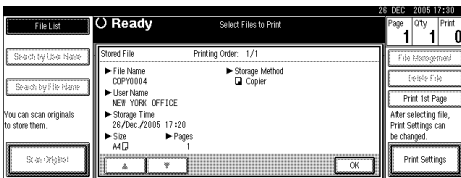

Detailed information about the document appears.

Note

- If you selected several documents, use **[▲]** and **[▼]** to view the details of each.
- Press **[OK]**. The Select Files to Print display reappears.

Printing Stored Documents

Note

- You can print stored documents from a network computer using a Web Image Monitor. For details about how to start the Web Image Monitor, see *Network Guide*.

- 1 Select a document you want to print.

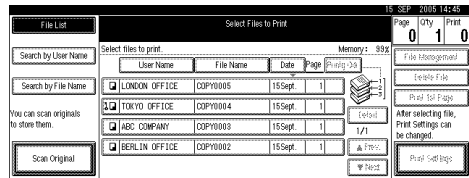

Note

- If a password is already set for the document, enter that password, and then press **[OK]**.
- You can search for a document using **[Search by User Name]** or **[Search by File Name]**. See p.41 "Searching for Stored Documents".
- You can sort document names in the list by user name, file name or date. To sort documents, press **[User Name]**, **[File Name]** or **[Date]**.
- If you cannot determine the contents of a document by its file name, you can print only the first page of the document for checking purposes. See p.44 "Printing first page".
- To cancel a selection, press the highlighted document again.

- 2 To print multiple documents, repeat step 1 in the order that you want to print.

Note

- You can select up to 30 documents.
- If sizes or resolutions of selected documents are not the same, the documents may not be printed.
- If you wish to change the order for printing, cancel the selection, and reselect in the desired order.

- If you press the **[Clear Modes]** key, selection of all documents will be canceled.
- If you press **[Printg Odr]**, the documents will be displayed in the order of printing.

3 If you need to change print settings, press **[Print Settings]**.

The Print Settings display appears. User names, file names, and print order of documents appear.

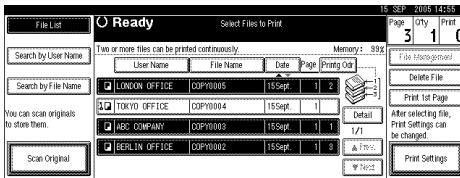

Note

- Print settings made for printing in copier or printer function remain after printing and applied to the next job. Print settings made in facsimile mode, however, do not remain.
- If you select multiple documents, print settings remain applied to the first document, but not to other documents.
- Print setting items are listed below. For details about print results of each setting, see *Copy Reference*.

❖ Binding format

- 2 Sided Copy Top to Top
- 2 Sided Copy Top to Bottom
- Booklet
- Magazine

❖ Cover handling

- Cover/Slip sheet
- Edit/Stamp

❖ Finish

- Sort
- Stack
- Staple
- If you print more than one set using the Sort function, you can check the print result by printing out only the first set. See p.44 "Sample copy".
- When multiple documents are printed at the same time, you can combine them into a single set by adjusting the print order.
- When multiple documents are printed at the same time, print settings made for the document printed first are applied to all other documents.
- If you select multiple files, you can check file names or print order selected in step 1 by scrolling the list using **[▼]** and **[▲]**.
- Press **[Select File]** to return to the Select Files to Print display.
- "Booklet", "Magazine", and "Stamp" cannot be set for documents saved in facsimile mode.
- "Booklet" and "Magazine" cannot be set for documents saved under multiple functions.

4 Enter the required number of prints using the number keys.

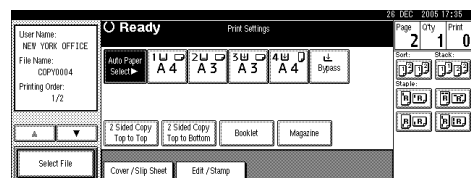

Note

- Up to 999 can be entered.

5 Press the **[Start]** key.

Printing starts.

To stop printing

1 Press the **[Clear/Stop]** key.

2 Press **[Stop]**.

Changing the number of copies during printing

Limitation

- The number of copies can only be changed when the Sort function is selected in the print settings.

1 Press the **[Clear/Stop]** key.

2 Press **[Change Quantity]**.

3 Enter a new number of copies using the number key.

4 Press the **[#]** key.

5 Press **[Continue]**.

Printing restarts.

Sample copy

If you print multiple sets using the Sort function, you can check the print order or print settings are correct by printing only the first set using the **[Sample Copy]** key.

Limitation

- This function can only be used when the Sort function is selected.

1 Select the document.

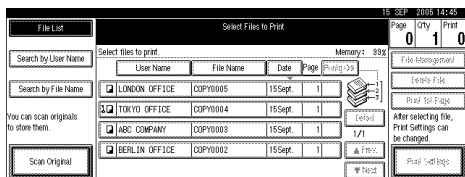

Note

- If a password is already set for the document, enter that password, and then press **[OK]**.
- You can search for the document by using **[Search by User Name]** or **[Search by File Name]** at the left top of the display. See p.41 "Searching for Stored Documents".
- You can sort document names in the list by user name, file name, or date. To sort documents, press **[User Name]**, **[File Name]**, or **[Date]**.
- To cancel a document selection, press it again.

2 Press the **[Sample Copy]** key.

The first set prints out.

3 If the sample is acceptable, press **[Print]**.

Note

- Press **[Suspend]** to cancel printing and return to the Print Settings menu to change settings.
-

Printing first page

You can print the first page of the document selected in the Select Files to Print display to check its content.

If more than one document selected, the first page of each is printed.

1 Select the document.

Note

- If a password is already set for the document, enter that password, and then press **[OK]**.

- You can search for the document by using **[Search by User Name]** or **[Search by File Name]** at the left top of the display. See p.41 “Searching for Stored Documents”.
- You can sort document names in the list by user name, file name, or date. To sort documents, press **[User Name]**, **[File Name]**, or **[Date]**.
- To cancel a document selection, press it again.

2 Press **[Print 1st Page]**.

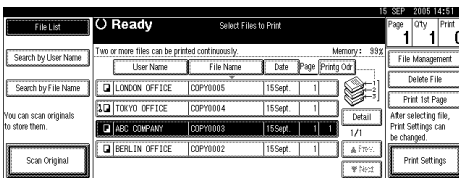

3 Press the **[Start]** key.

Deleting Stored Documents

Important

- You can store up to 3,000 documents in the Document Server. No more documents can be stored when the total is 3,000. You should delete unnecessary documents to increase available memory.

Note

- You can delete all stored documents at once with User Tools. See p.67 “Delete All Files in Document Server”.
- You can delete stored documents from a network computer using the Web Image Monitor. For details about how to start the Web Image Monitor, see *Network Guide*.

1 Press the **[Document Server]** key.

2 Select the document to delete.

Note

- If a password is already set for the document, enter that password, and then press **[OK]**.

- You can delete multiple documents at once.

- You can search for a document by using **[Search by User Name]** or **[Search by File Name]** at the left top of the display. See p.41 “Searching for Stored Documents”.

- You can sort document names in the list by the user name, file name, or date. To sort documents, press **[User Name]**, **[File Name]**, or **[Date]**.

- If you cannot find the document by name, you can print the first page of a document to check its contents. See p.44 “Printing first page”.

- Press the selected line again to cancel the print job.

3 Press **[Delete File]**.

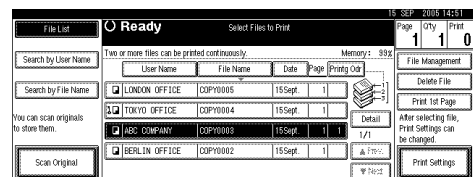

4 Press **[Delete]** to delete the document.

Viewing Stored Documents Using a Web Image Monitor

Reference

The Web Image Monitor's Help

1 Start a Web Image Monitor.

2 Enter "http:// (IP address of this machine) /" in the [Address] box.

The top page appears on the Web Image Monitor.

3 Click [Document Server].

The [Document Server File List] appears.

Note

- To switch the display format, click [Details], [Thumbnails] or [Icons] from the [Display method] list.

4 Click the properties button of the document you want to check.

Information about that document appears.

5 Check the document's content.

Note

- To enlarge the document preview, click [Enlarge Image].

Downloading Stored Documents

Note

- File Format Converter is required when downloading documents stored in copier or printer mode.

1 Start a Web Image Monitor.

2 Enter "http:// (IP address of this machine) /" in the [Address] box.

The top page appears on the Web Image Monitor.

3 Click [Document Server].

The [Document Server File List] appears.

Note

- To switch the display format, click [Details], [Thumbnails] or [Icons] from the [Display method] list.

4 Click the properties button of the document you want to download.

5 Select [PDF] or [Multi-page TIFF] in the [File format] list.

Note

- [Multi-page TIFF] is available when file format converter is installed.
- [Multi-page TIFF] cannot be selected for documents stored in copier or printer mode.

6 Click [Download].

7 Click [OK].

Settings for the Document Server

❖ Copier/Document Server Features (See "General Features P4/4", *Copy Reference*.)

Items	Default	
General Features	Document Server Storage Key:F1	<i>2 Sided Original Top to Top</i>
	Document Server Storage Key:F2	<i>1 Sided→1 Sided Combine</i>
	Document Server Storage Key:F3	<i>1 Sided→1 Sided Combine: 4 originals</i>
	Document Server Storage Key:F4	<i>1 Sided→1 Sided Combine: 8 originals</i>
	Document Server Storage Key:F5	<i>Create Margin</i>

❖ System Settings (See p.53 "General Features", p.56 "Tray Paper Settings", p.59 "Timer Settings", and p.62 "Administrator Tools".)

	Items	Default
General Features	Warm Up Notice	<i>On</i>
	Copy Count Display	<i>Up</i>
	Output: Document Server	<i>Internal Tray 1</i>
Tray Paper Settings	Paper Tray Priority: Copier	<i>Tray 1</i>
	Cover Sheet Tray	<i>Off</i>
	Slip Sheet Tray	<i>Off</i>
Timer Settings	Copier/Document Server Auto Reset Timer	<i>60 seconds</i>
Administrator Tools	Auto Delete File in Document Server	<i>Yes After 3 day(s)</i>
	Delete All Files in Document Server	<i>--</i>

4. User Tools (System Settings)

User Tools Menu (System Settings)

Reference









For details about Interface Settings and File Transfer, see “User Tools Menu (System Settings)”, *Network Guide*.

For details about parallel interface, see “System Settings (Parallel Connection)”, *Printer Reference*.

❖ General Features (See p.53 “General Features”.)

	Default
Panel Tone	<i>On</i>
Warm Up Notice	<i>On</i>
Copy Count Display	<i>Up</i>
Function Priority	<i>Copier</i>
Print Priority	<i>Display Mode</i>
Function Reset Timer	<i>3 seconds</i>
Output: Copier	<i>Internal Tray 1</i>
Output: Document Server	<i>Internal Tray 1</i>
Output: Facsimile	<i>Internal Tray 2</i>
Output: Printer	<i>Internal Tray 1</i>
<F/F4>Size Setting	<i>8¹/₂" x 13" </i>

❖ **Tray Paper Settings (See p.56 “Tray Paper Settings”.)**

	Default
Paper Tray Priority: Copier	Tray 1
Paper Tray Priority: Facsimile	Tray 1
Paper Tray Priority: Printer	Tray 1
Tray Paper Size: Tray 1	A4  , 8 ¹ / ₂ " × 11" 
Tray Paper Size: Tray 2	A3  , 11" × 17" 
Tray Paper Size: Tray 3	A4  , 8 ¹ / ₂ " × 11" 
Tray Paper Size: Tray 4	A4  , 8 ¹ / ₂ " × 14" 
Paper Type: Bypass tray	No Display
Paper Type: Tray 1	No Display/2 Sided Copy/Auto Paper Select On
Paper Type: Tray 2	No Display/2 Sided Copy/Auto Paper Select On
Paper Type: Tray 3	No Display/2 Sided Copy/Auto Paper Select On
Paper Type: Tray 4	No Display/2 Sided Copy/Auto Paper Select On
Front Cover Sheet Tray	Off
Slip Sheet Tray	Off
Printer Bypass Paper Size	A4 

❖ **Timer Settings (See p.59 “Timer Settings”.)**

	Default
Auto Off Timer	1 minute(s)
Panel Off Timer	1 minute(s)
System Auto Reset Timer	60 seconds
Copier / Document Server Auto Reset Timer	60 seconds
Facsimile Auto Reset Timer	30 seconds
Printer Auto Reset Timer	60 seconds
Scanner Auto Reset Timer	60 seconds
Set Date	--
Set Time	--
Auto Logout Timer	60 seconds

❖ **Interface Settings**

- For details about network settings, see “User Tools Menu (System Settings)”, *Network Guide*.
- For details about parallel interface, see “System Settings (Parallel Collection)”, *Printer Reference*.

❖ **File Transfer**

- For details about network settings, see “User Tools Menu (System Settings)”, *Network Guide*.

❖ **Administrator Tools (See p.62 “Administrator Tools”.)**

	Default
User Authentication Management	<i>Off</i>
Administrator Authentication Management	<i>Off</i>
Program / Change Administrator	--
Key Counter Management	--
Extended Security	--
Display / Print Counter	--
Display / Clear / Print Counter per User	--
Address Book Management	--
Address Book:Program/Change/Delete Group	--
Address Book:Program/Change/Delete Transfer Request	--
Address Book : Change Order	--
Print Address Book: Destination List	--
Address Book : Edit Title	--
Address Book:Select Title	<i>Title 1</i>
Auto Delete File in Document Server	<i>After 3 day(s)</i>
Delete All Files in Document Server	--
Program / Change / Delete LDAP Server	--
Use LDAP Server	<i>Off</i>
AOF (Always On)	<i>On</i>
Firmware Version	--
Network Security Level	<i>Level 0</i>
Reduce Recovery Time	<i>Off</i>
Delete All Logs	<i>Off</i>
Transfer Log Setting	<i>Off</i>
Unauthorized Copy Control	<i>Off</i>

Accessing User Tools (System Settings)

This section is for key operators in charge of this machine.

User Tools allow you to change or set defaults.

Note

- ❑ Operations for System Settings differ from normal operations. Always quit User Tools when you have finished. See p.52 “Exiting User Tools”.
- ❑ Any changes you make with User Tools remain in effect even if the main power switch or operation switch is turned off, or the **[Energy Saver]** or **[Clear Modes]** key is pressed.

4

Changing Default Settings

Note

- ❑ If the Administrator Authentication is specified, contact your administrator.

- 1 Press the **[User Tools/Counter]** key.

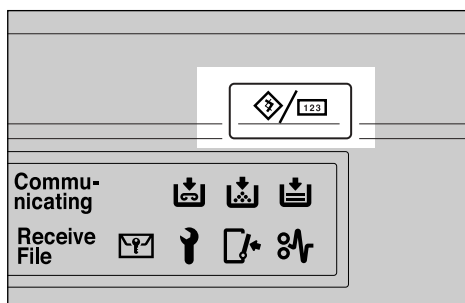

ZFFH220E

- 2 Press **[System Settings]**.

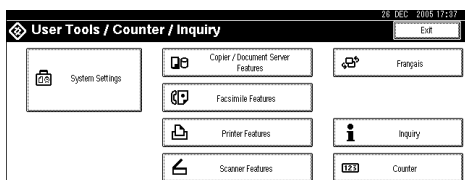

- 3 Select the menu, and then press the appropriate key.

Reference

p.49 “User Tools Menu (System Settings)”

- 4 Change settings by following instructions on the display panel, and then press **[OK]**.

Note

- ❑ To cancel changes made to settings and return to the initial display, press the **[User Tools/Counter]** key.

Exiting User Tools

- 1 Press the **[User Tools/Counter]** key.

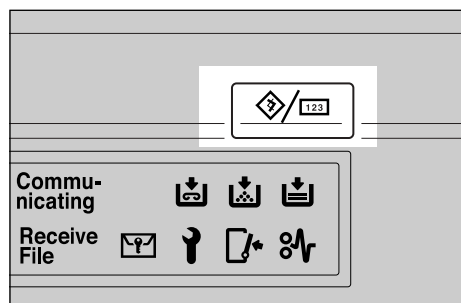

ZFFH220E

Note

- ❑ You can also exit User Tools by pressing **[Exit]**.

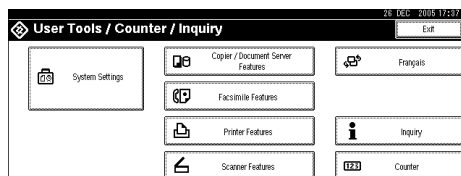

Settings You Can Change with User Tools

Reference

To access User Tools, see p.52 “Accessing User Tools (System Settings)”.

General Features

❖ Panel Tone

The beeper (key tone) sounds when a key is pressed.

Note

Default: *On*

❖ Warm Up Notice (copier/Document Server)

You can have the beeper sound when the machine becomes ready to copy after leaving Energy Saver mode, or when the power is turned on.

Note

If the Panel Tone setting is “OFF”, the beeper does not sound, whatever the Warm Up Notice setting.

Default: *On*

❖ Copy Count Display (copier/Document Server)

The copy counter can be set to show the number of copies made (count up) or the number of copies yet to be made (count down).

Note

Default: *Up (count up)*

❖ Function Priority

You can specify the mode to be displayed immediately after the operation switch is turned on, or when System Reset mode is turned on.

Note

Default: *Copier*

❖ Print Priority

Print Priority is given to the mode selected.

Reference

p.31 “Multi-Access”

Note

Default: *Display Mode*

When [**Interleave**] is selected, the current print job will be interrupted after a maximum of five sheets.

- ❑ When the Internal Tray 2 (1 bin tray), Shift Sort Tray, 500-sheet finisher, or 1000-sheet finisher is installed on the machine, you can specify an output tray for each documents are delivered. For details about how to specify an output tray for each function, see the following sections:

- p.54 “Output: Copier (copier)”
- p.55 “Output: Document Server (Document Server)”
- p.55 “Output: Facsimile (facsimile)”
- p.55 “Output: Printer (printer)”

❖ Function Reset Timer

You can set the length of time the machine waits before changing modes when using the multi-access function (see p.31 “Multi-Access”). This is useful if you are making many copies and have to change settings for each copy. If you set a longer reset period, you can prevent interruption from other functions.

Note

- ❑ Default: *Set Time*
- ❑ The Function Reset Timer setting is ignored if **[Interleave]** is set for Print Priority (see p.53 “Print Priority”).
- ❑ When you select **[Set Time]**, enter the time (3–30 seconds, in 1 second increments) using the number keys.
- ❑ The default time is three seconds.

❖ Output: Copier (copier)

You can specify a tray to which documents are delivered.

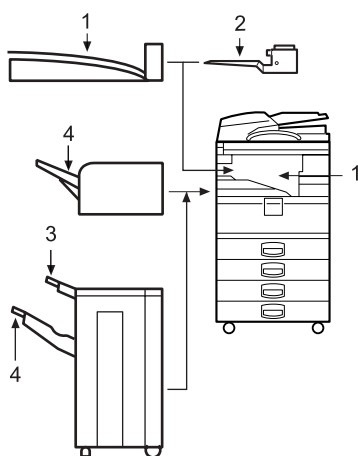

AHR009S

1. Internal Tray 1

2. Internal Tray 2

3. Finisher Upper Tray

4. Finisher Shift Tray

 **Note**

- Default: *Internal Tray 1*

❖ Output: Document Server (Document Server)

You can specify a tray to which documents are delivered.

 **Note**

- Default: *Internal Tray 1*
- For details about output trays, see p.54 “Output: Copier (copier)”.

❖ Output: Facsimile (facsimile)

You can specify a tray to which documents are delivered.

 **Note**

- Default: *Internal Tray 2*
- For details about output trays, see p.54 “Output: Copier (copier)”.



❖ Output: Printer (printer)

You can specify a tray to which documents are delivered.

 **Note**

- Default: *Internal Tray 1*
- The output trays set on the printer driver have priority over the output tray specified above.
- For details about output trays, see p.54 “Output: Copier (copier)”.

❖ <F/F4>Size Setting

Currently three types of F size are available; 8¹/₂"×13", 8¹/₄"×13" and 8"×13". The ADF or exposure glass cover sensor cannot distinguish these three types of originals. This function sets the F size from the ADF or exposure glass cover sensor. Auto Paper Select or Auto Reduce/Enlarge can be used for F size originals based on this setting.

 **Note**

- Default: 8¹/₂"×13"

Output tray settings

 **Limitation**

- You cannot interrupt the current job with a different function job that specifies stapling or sorting.
- You can interrupt the current job with an ordinary copy job or facsimile reception. The output tray used when the job is interrupted varies depending on the type of finisher shift tray and output tray specified for interruption.

❖ **When 500-sheet finisher is the finisher shift tray:**

- When the output tray specified for the interrupting job is the finisher tray, the interrupting job will be delivered to internal tray 1.
- When the output tray specified for the interrupting job is not the finisher tray, the interrupting job will be delivered to the specified output tray.

❖ **When 1000-sheet finisher is the finisher shift tray:**

- When the output tray specified for the interrupting job is the finisher tray, the interrupting job will be delivered to the finisher upper tray.
 - When the output tray specified for the interrupting job is not the finisher tray, the interrupting job will be delivered to the specified output tray.
- When the 500-sheet finisher or 1000-sheet finisher is installed and stapling is specified for a job, the job will be delivered to the finisher shift tray, regardless of the output tray specified.

Tray Paper Settings

❖ **Paper Tray Priority: Copier (copier/Document Server)**

You can specify the tray to supply paper for output.

 **Note**

Default: *Tray 1*

❖ **Paper Tray Priority: Facsimile (facsimile)**

You can specify the tray to supply paper for output.

 **Note**

Default: *Tray 1*

❖ **Paper Tray Priority: Printer (printer)**

You can specify the tray to supply paper for output.

 **Note**

Default: *Tray 1*

❖ **Tray Paper Size: Tray 1–4**

Select the size of the paper loaded in the paper tray.

❖ **The paper sizes you can set for trays 1, 3 and 4 are as follows:**

- A3 , B4 JIS , A4 , A4 , B5 JIS , B5 JIS , A5 , 8K , 16K , 16K
- 11"×17" , 8¹/₂"×14" , 8¹/₂"×11" , 8¹/₂"×11" , 5¹/₂"×8¹/₂" , 7¹/₄"×10¹/₂" , 8"×13" , 8¹/₂"×13" , 8¹/₄"×13" , 11"×14" , 8¹/₄"×14" , 8"×10¹/₂" , 8"×10¹/₂" , custom size (140-297 mm (5.52"-11.69") wide × 182-432 mm (7.17"-17.00") long)

❖ **The paper sizes you can set for tray 2 are as follows:**

- A3☐, B4 JIS☐, A4☐, A4☐, B5 JIS☐, B5 JIS☐, A5☐, B6 JIS☐, A6☐, Postcard☐, 8K☐, 16K☐, 16K☐
- 11"×17"☐, 8¹/₂"×14"☐, 8¹/₂"×11"☐, 8¹/₂"×11"☐, 5¹/₂"×8¹/₂"☐, 7¹/₄"×10¹/₂"☐, 7¹/₄"×10¹/₂"☐, 8"×13"☐, 8¹/₂"×13"☐, 8¹/₄"×13"☐, 11"×14"☐, 11"×15"☐, 10"×14"☐, 10"×15"☐, 8¹/₄"×14"☐, 8"×10¹/₂"☐, 8"×10¹/₂"☐, 8"×10"☐, 8"×10"☐, C5☐, C6☐, DL Env☐, 4¹/₈"×9¹/₂"☐, 3⁷/₈"×7¹/₂"☐, custom size (100-297 mm (3.97"-11.69") wide x 148-432 mm (5.83"-17.00") long)

 **Reference**

p.132 "Changing the Paper Size"

 **Important**

- ☐ If the specified paper size differs from the actual size of the paper loaded in the paper tray, a misfeed might occur because the correct paper size was not detected.

 **Note**

- ☐ The paper guide for the optional LCT is fixed for A4☐, 8¹/₂"×11"☐ size paper. Contact your service representative if you need to change the paper size.
- ☐ If the paper size set for the selector in paper tray is different to the paper size for this setting, the paper size of the dial has priority.
- ☐ If you load paper of a size not indicated on the paper size selector in the paper tray, set the dial to "*".
- ☐ Default:
 - Tray 1: A4☐, 8¹/₂" × 11"☐
 - Tray 2: A3☐, 11" × 17"☐
 - Tray 3: A4☐, 8¹/₂" × 11"☐
 - Tray 4: A4☐, 8¹/₂" × 14"☐

 **Reference**

p.132 "Changing the Paper Size"

❖ **Paper Type: Bypass tray**

Sets the display so you can see what type of paper is loaded in the bypass tray.

❖ **The paper types you can set for the bypass tray are as follows:**

- No Display, Recycled Paper, Special Paper, Colour Paper, Letterhead, Preprinted Paper, Label Paper, Bond Paper, Thick Paper, OHP, Thin Paper, Cardstock

 **Note**

- ☐ Default: *No Display*

❖ **Paper Type: Tray 1–4**

Sets the display so you can see what type of paper is loaded in each paper tray. The print function uses this information to automatically select the paper tray.

❖ **The paper types you can set for trays 1, 3 and 4 are as follows:**

- No Display, Recycled Paper, Special Paper, Colour Paper, Letterhead, Preprinted Paper, Bond Paper, Cardstock

❖ **The paper types you can set for tray 2 are as follows:**

- No Display, Recycled Paper, Special Paper, Colour Paper, Letterhead, Preprinted Paper, Label Paper, Bond Paper, Thick Paper, OHP, Thin Paper, Cardstock

4

 **Note** Default:

- Paper Type: *No Display*
- Copying Method in Duplex: *2 Sided Copy*
- Apply Auto Paper Select: *Yes*

When paper of the same type and size is loaded in two different paper trays and you want to specify tray for 2 Sided Copy and tray for 1 Sided Copy, specify the upper tray for 2 Sided Copy. If one of the trays is specified as the default in Paper Tray Priority, assign 2 Sided Copy to that tray.

A  appears next to the paper tray if **[No]** is selected in Auto Paper Select.

 **Limitation**

[Auto Paper Select] can only be selected for the copier function if **[No Display]** and **[Recycled Paper]** are selected. If **[No]** is selected, Auto Paper Select is not valid for the tray.

❖ **Front Cover Sheet Tray**

Allows you to specify and display the paper tray that is setting cover sheets. After selecting the paper tray, you can also specify the display timing and copy method for two-sided copying.

 **Note** Default:

- Tray to Program: *Off*

Functions using the cover sheet tray setting are the front cover function and front/back cover function.

When **[At Mode Selected]** is selected, cover sheet tray settings only appear when the cover function or slip sheet function is selected.

When **[Full Time]** is selected, the cover sheet tray is always displayed.

You can set Copying Method in Duplex only when **[At Mode Selected]** is selected.

 **Reference**

“Covers”, *Copy Reference*

❖ Slip Sheet Tray

Allows you to specify and display the paper tray that is inserting slip sheets. After selecting the paper tray, you can also specify the display timing and copy method for two-sided copying.

Note

Default:

- Tray to Program: *Off*

When [**At Mode Selected**] is selected, slip sheet tray settings only appear when the cover function or slip sheet function is selected.

Reference

"Slip Sheets", *Copy Reference*

❖ Printer Bypass Paper Size

You can specify the size of the paper in the bypass tray when printing data from the computer.

- The paper types you can set for trays are as follows:

A3 , B4 JIS , A4 , A4 , B5 JIS , B5 JIS , A5 , A5 , A6 ,
 11" × 17" , 8¹/₂" × 14" , 8¹/₂" × 11" , 8¹/₂" × 11" , 5¹/₂" × 8¹/₂" ,
 7¹/₄" × 10¹/₂" , 7¹/₄" × 10¹/₂" , 8" × 13" , 8¹/₂" × 13" , 8¹/₄" × 13" ,
 4¹/₈" × 9¹/₂" , 3⁷/₈" × 7¹/₂" , C5 Env , C6 Env , DL Env , 8K ,
 16K , 16K

Note

Default: A4

You can specify a custom size of between 90.0 and 297.0 mm (3.6"-11.7") vertically, and between 148.0 and 600.0 mm (5.9"-23.6") horizontally.

Timer Settings

❖ Auto Off Timer

After a specified period has passed, following job completion, the machine automatically turns off, in order to conserve energy. This function is called "Auto Off".

The machine status after the Auto Off operation is referred to as "Off mode", or "Sleep mode". For the Auto Off Timer, specify the time to elapse before Auto Off.

Note

Default: *1 minute*

Enter a time interval between 10 seconds and 240 minutes, using the number keys

From "Off mode" or "Sleep mode", the machine is ready to use within 10 seconds.

Auto Off may not work when error messages appear.

- The machine may not shift to "Sleep Mode" at the set time, if the main power switch has just been turned on and functions other than copier function are still in the process of starting up.

❖ Panel Off Timer

Set the amount of time the machine waits before switching the panel off after copying has finished or performing the last operation.

Note

- Default: *1 minute*
- Enter a time interval between 10 seconds and 240 minutes, using the number keys.

❖ System Auto Reset Timer

The System Reset setting automatically switches the screen to that of the function set in Function Priority. When no operations are in progress, or when an interrupted job is cleared. This setting determines the system reset interval. See p.53 "Function Priority".

Note

- Default: *On, 60 seconds*
- The time can be set from 10 to 999 seconds, using the number keys.

❖ Copier/Document Server Auto Reset Timer (copier/Document Server)

Specifies the time to elapse before copier and Document Server modes reset.

Note

- If **[Off]** is selected, the machine does not automatically switch to the user code entry screen.
- Default: *On, 60 seconds*
- The time can be set from 10 to 999 seconds, using the number keys.

❖ Facsimile Auto Reset Timer (facsimile)

Specifies the time to elapse before the facsimile mode resets.

Note

- Default: *30 seconds*
- The time can be set from 30 to 999 seconds, using the number keys.

❖ Printer Auto Reset Timer (printer)

Specifies the time to elapse before the printer function resets.

Note

- Default: *On, 60 seconds*
- If **[Off]** is selected, the machine does not automatically switch to the user code entry screen.
- The time can be set from 10 to 999 seconds, using the number keys.

❖ Scanner Auto Reset Timer (scanner)

Specifies the time to elapse before the scanner function resets.

 Note

- If **[Off]** is selected, the machine does not automatically switch to the user code entry screen.
- Default: *On, 60 seconds*
- The time can be set from 10 to 999 seconds, using the number keys.

❖ Set Date

Set the date for the copier's internal clock using the number keys.

 Note

- To change between year, month, and day, press [**←**] and [**→**].

❖ Set Time

Set the time for the copier's internal clock using the number keys.

 Note

- To change between hours, minutes and seconds, press [**←**] and [**→**].
- Enter the time using the 24-hour format (in 1 second increments).

❖ Auto Logout Timer

You can specify whether or not to automatically log out a user when the user does not operate the machine for a specified period of time after logging in.

 Note

- Default: *On, 60 seconds*
- When **[On]** is selected, the time can be set from 10 to 999 seconds, in one second increments, using the number keys

Administrator Tools

Administrator Tools are used by the administrator. To change these settings, contact the administrator.

We recommend specifying Administrator Authentication before making Administrator Tools settings.

See *Security Reference*.

❖ User Authentication Management

- User Code Authentication
Using User Code Authentication, you can limit the available functions and supervise their use.

When using User Code Authentication, register the user code.

See p.74 “Authentication Information”.

- Copier
- Document Server
- Facsimile
- Scanner
- Printer
- Printer: PC Control

Note

- Using the Printer PC Control function, you can obtain a log of prints corresponding to the codes entered using the printer driver.

- Basic Authentication
- Windows Authentication
- LDAP Authentication
- Intergration Server Authentication
- Off

Note

- Default: *Off*

Reference

For details about Basic Authentication, Windows Authentication, LDAP Authentication, and Intergration Server Authentication, see *Security Reference*.

❖ Administrator Authentication Management

See *Security Reference*.

❖ Program / Change Administrator

See *Security Reference*.

❖ Key Counter Management

You can specify that functions that you want to manage with the key counter.

❖ Extended Security

You can specify whether or not to use the extended security functions. For details about the extended security functions, see *Security Reference*.

❖ Display / Print Counter

Allows you to view and print the various counters.

- Display/Print Counter
Displays counters for each functions (Total, Copier, Facsimile, Printer, A3/DLT, Duplex, Staple).
- Print Counter List
Prints out a list of counters for each functions.
- To print the counter list
 - ① Press the **[User Tools/Counter]** key.
 - ② Press **[System Settings]**.
 - ③ Press **[Administrator Tools]**.
 - ④ Press **[Display / Print Counter]**.
 - ⑤ Press **[Print Counter List]**.

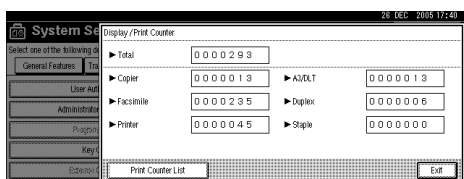

- ⑥ Press the **[Start]** key.
- ⑦ Press **[Exit]**.

❖ Display/Clear/Print Counter per User Code

Allows you to view and print the numbers of prints accessed with user codes, and to set those values to 0.

Note

- Press **[▲]** and **[▼]** to show all the numbers of prints.
- The number of prints may differ from the counter value shown in Display/Print Counter.
 - Print Counter for All Users
Prints the counter values for all the users.
 - Clear Counter for All Users
Sets the counter value for all the users.
 - Print Counter per User
Prints the counter values for each user.
 - Clear Counter per User
Sets the counter value for each user.

 **Note**

- To print a list for each user, see p.76 “Printing the Counter for Each User Code”.

❖ Address Book Management

You can add, change or delete information registered in the Address Book. For details, see p.69 “Address Book”.

- **[Program / Change]**

You can register and change names as well as user codes.

- **Names**
You can register a name, key display, registration number, and title selection.
- **Auth. Info**
You can register a user code, and specify the functions available to each user code. You can also register user names and passwords to be used when sending e-mail, sending files to folders, or accessing an LDAP server.
- **Protection**
You can register a protection code.
- **Fax Dest.**
You can register a fax number, international TX mode, fax header, label insertion, IP-Fax destination, and protocol.
- **E-mail**
You can register an e-mail address.
- **Folder**
you can register the protocol, path, port number, and server name.
- **Add to Group**
You can put names registered in the Address Book into a group.
- **[Delete]**
You can delete a name from the Address Book.

 **Note**

- You can register up to 2,000 names.
- You can register up to 100 user codes. If you add the optional user account enhance unit, you can register up to 500 user codes.
- You can also register user codes from SmartDeviceMonitor for Admin. (printer option required)
- You can also register and manage data in the Address Book using a Web Image Monitor. See the Web Image Monitor's help.

❖ Address Book: Program / Change / Delete Group

Names registered in the Address Book can be added into a group. You can then easily manage the names registered in each group. For details, see p.102 “Registering Names to a Group”.

- **[Program / Change]**

You can register new groups, or changes a group name, key display, title selection or registration number.

- **[Delete]**

You can delete a group.

Note

- You can register up to 100 groups.
- You can also group users using a Web Image Monitor. For more information, see the Web Image Monitor help.

❖ Address Book: Program / Change / Delete Transfer Request

You can register fax destinations for the Transfer Request function in facsimile mode.

For details about operations, see p.109 “Registering the Transfer Request”.

- **Program / Change**

This registers new transfer requests and receiving stations, or changes the transfer request name, key name, title selection, registration number, fax destination, IP-Fax destination, or e-mail address.

- **[Delete]**

Deletes a transfer request.

Note

- You can register up to 10 transfer requests.

❖ Address Book: Change Order

You can change the order of the names in the Address Book.

Note

- You can rearrange the order of items that are on the same page, but you cannot move the items to another page. For example, you cannot move an item from “PLANNING” ([OPQ]) to “DAILY” ([CD]).

- ① Press the **[User Tools/Counter]** key.
- ② Press **[System Settings]**.
- ③ Press **[Administrator Tools]**, and then press **[▼Next]**.
- ④ Press **[Address Book: Change Order]**.
- ⑤ Press the name key to be moved.

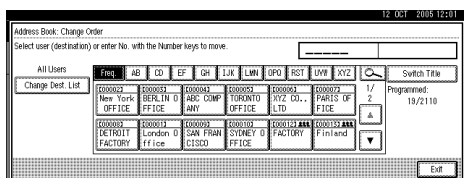

 **Note**

- You can also select a name using the number keys.
- ⑥ Press the name key in the place that you want to move to.

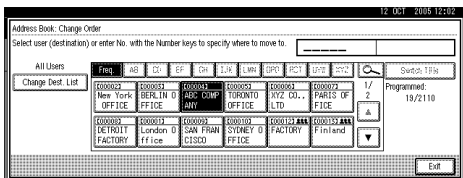

The name selected in step ⑤ moves to the place selected in step ⑥, and the keys for other names will be shifted accordingly.

4

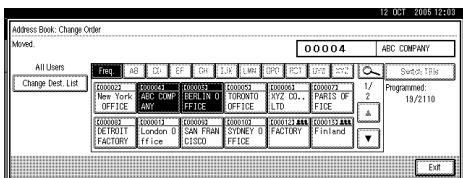

 **Note**

- You can also select a name using the number keys.

❖ **Print Address Book: Destination List**

You can print the destination list registered in the Address Book.

- **Print in Title 1 Order**
Prints the Address Book in Title 1 order.
- **Print in Title 2 Order**
Prints the Address Book in Title 2 order.
- **Print in Title 3 Order**
Prints the Address Book in Title 3 order.
- **Print Group Dial List**
Prints the group Address Book.

- ① Select the print format.
- ② To print the list on two-sided pages, select **[Print on 2 Sides]**.
- ③ Press the **[Start]** key.
The list prints out.

❖ **Address Book: Edit Title**

You can edit the title to easily find a user.

- ① Press the **[User Tools/Counter]** key.
- ② Press **[System Settings]**.
- ③ Press **[Administrator Tools]**, and then press **[▼Next]**.
- ④ Press **[Address Book: Edit Title]**.

- ⑤ Press the title key you want to change.

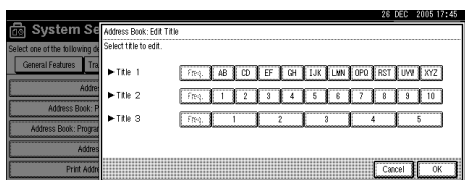

- ⑥ Enter the new name, and then press **[OK]**.

- ⑦ Press **[OK]**.

❖ Address Book: Select Title

You can specify the title to select a name.

Note

- Default: *Title 1*

❖ Auto Delete File in Document Server

You can specify whether documents stored in the Document Server will or will not be deleted after a specified period of time.

Note

- Default: *Yes After 3 day(s)*
- If you select **[Yes]**, documents stored subsequently are deleted after the specified period.
- If you select **[No]**, documents are not automatically deleted.
- If you select **[Yes]**, enter a number of days from of 1 to 180 (in 1 day increments).
- The default is three days, this means documents are deleted three days (72 hours) after they are stored.

❖ Delete All Files in Document Server

You can delete files stored in the Document Server, including files stored for Sample Print, Locked Print, Hold Print, and Stored Print under the printer function.

Note

- Even if a password is already set, all documents are deleted.
- A confirmation message appears. To delete all documents, select **[Yes]**.

❖ Program / Change / Delete LDAP Server

See "Program / Change / Delete LDAP Server", *Network Guide*.

❖ Use LDAP Server

You can specify whether or not to use the LDAP server for searching.

 Note

Default: *Off*

When Use LDAP Server is set to Off, **[Search LDAP]** will not appear on the searching display.

❖ AOF (Always ON)

Specify whether or not to use Auto Off.

 Note

Default: *On*

❖ Firmware Version

You can check the version of the softwares installed in this machine.

❖ Network Security Level

For details about this function, consult your administrator.

❖ Reduce Recovery Time

You can specify whether or not to shorten the recovery time.

If you press **[On]**, the recovery time is shortened.

If you press **[Off]**, the recovery time is lengthened and the machine's power consumption is reduced.

 Note

Default: *Off*

This setting appears only if the copier unit and hard disk are installed in the machine.

❖ Delete All Logs

For details about this function, consult your administrator.

❖ Transfer Log Setting

For details about this function, consult your administrator.

❖ Unauthorized Copy Control

For details about this function, consult your administrator.

5. Registering Addresses and Users for Facsimile/Scanner Functions

Address Book

Registering information such as the names of users and their e-mail addresses in the Address Book allows you to manage them easily.

Important

- ❑ Address Book data is stored on the hard disk. It can be lost if there is some kind of hard disk failure. The manufacturer shall not be responsible for any damages resulting data loss.

Note

- ❑ You can also use a Web Image Monitor to register names in the Address Book. With the SmartDeviceMonitor for Admin, you can register multiple names at the same time.
- ❑ Using [Address Management Tool] in SmartDeviceMonitor for Admin, you can backup Address Book data. We recommend backing up data when using the Address Book.
- ❑ Printer option is required to use SmartDeviceMonitor for Admin.

Reference

For details about using a Web Image Monitor, see the Web Image Monitor Help.

For details about SmartDeviceMonitor for Admin and how to install it, see *Printer Reference*.

For operating instructions, see SmartDeviceMonitor for Admin Help.

You can register and manage the following items in the Address Book:

❖ Name

You can register the name of the user and the key display. This is the basic information required for managing user of the machine.

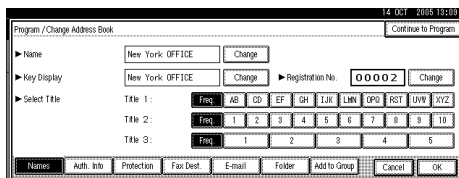

❖ Authentication Information

You can register user codes in order to restrict particular functions to certain users, and to check their use of each function. You can also register login user names and login passwords to be used when sending e-mail, sending to folders, or accessing an LDAP server.

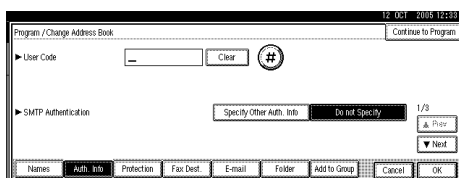

❖ Fax Dest.

You can register fax numbers, line, fax header and select label insertion.

When using IP-Fax, you can register the IP-Fax destination and select the protocol.

- Fax Destination

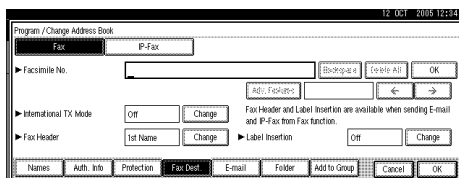

- IP-Fax Destination

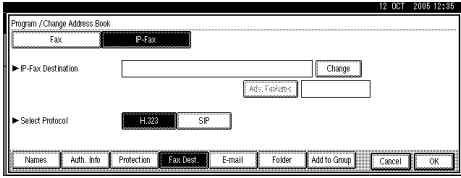

- ❖ E-mail

You can register e-mail destinations in the Address Book.

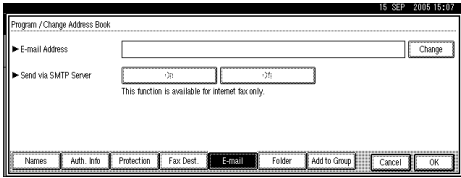

- ❖ Folder

You can register the protocol, path name and server name.

- SMB

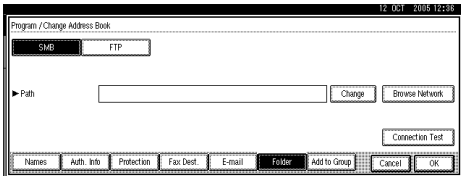

- FTP

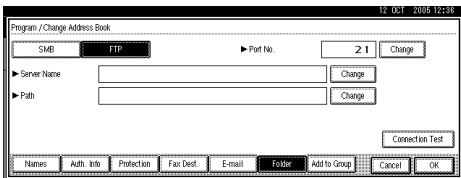

- NCP

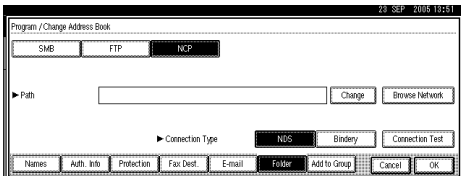

- ❖ Protection

You can set protection codes to stop sender's name from being used or folders from being accessed without authorization.

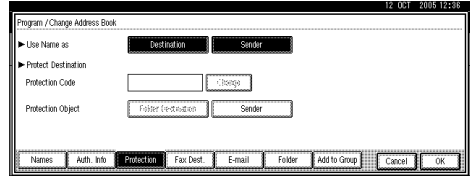

- ❖ Add to Group

You can put registered e-mail and folder destinations into a group for easier management.

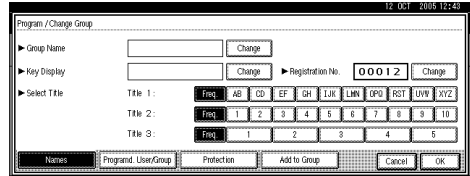

Managing names in the Address Book

By registering a name and key display beforehand, you can specify e-mail and folder destinations simply by selecting the name key.

See p.72 "Registering Names".

Sending fax by Quick Dial

Register a fax number in the Address Book so you can specify it only by selecting the fax destination, shown on the fax initial display when sending a fax. When label insertion is set to "ON", the receiver's name and standard messages are printed on the fax message when it is received at the other end.

By registering IP-Fax destinations in the Address Book, you can specify a destination simply by selecting it from the destinations that appear in the initial fax display.

Registered IP-Fax numbers can be used and printed as sender's IP-Fax numbers.

See p.79 "Fax Destination".

Sending e-mail by Quick Dial

By registering e-mail addresses in the Address Book, you can specify e-mail destinations simply by selecting them from the fax initial display when sending a document by internet fax.

You can also specify an e-mail address by selecting the destination shown on the initial scanner display when sending a document using the scanner function.

A registered e-mail address can be used as the sender's address, and the sender's address are automatically entered in the "From" field of an e-mail header.

See p.88 "E-mail Destination".

Sending scanned files to a shared folder directly

After registering the path name, user name and password, you can connect to a shared folder simply by selecting the destination shown on the initial scanner display whenever sending files using the scanner function to a shared folder.

To share the folder using Windows, select the SMB protocol.

To register the folder to the FTP server, select the FTP protocol.

To register the folder to the NetWare server, select the NCP protocol.

See p.91 "Registering Folders".

Preventing unauthorized user access to shared folders from the machine

After registering a protection code, you can specify the object of protection to prevent an e-mail destination from being used without permission.

You can prevent unauthorized access to registered folders. See p.107 "Registering a Protection Code".

Managing users and machine usage

Register user codes to limit users to the following functions and check their use of each function:

- Copier
- Document Server
- Facsimile
- Scanner
- Printer

See p.74 "Authentication Information".

Registering Names

The user name is useful for selecting a destination when sending faxes or e-mail. You can also use it as a folder destination.

Registering a Name

1 Press the **[User Tools/Counter]** key.

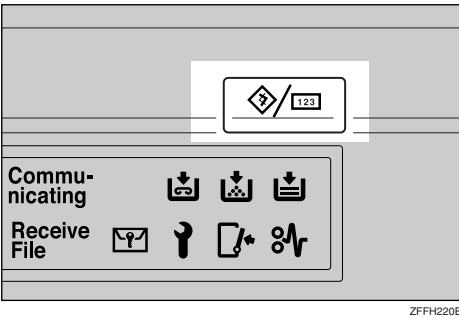

ZFFH220E

2 Press **[System Settings]**.

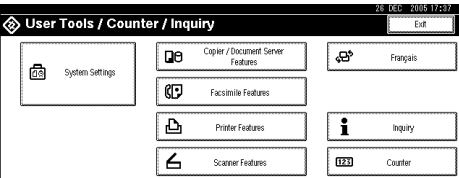

3 Press **[Administrator Tools]**, and then press **[▼Next]**.

4 Press **[Address Book Management]**.

5 Press **[New Program]**.

6 Press **[Change]** on the right of the Name.

The name entry display appears.

7 Enter the name, and then press **[OK]**.

Note

- The name can be used for documents in the Document Server. For details about the Document Server, see p.37 "Using the Document Server".
- You can register up to 2000 programs and allocate them registration numbers between 00001 and 50000.
- Registration numbers are initially assigned automatically, but you can change them afterward. To change a registration number, press **[Change]** to the right of "Registration No.", and enter a new number using the number keys.

Reference

p.149 "Entering Text"

8 Press the key for the classification you want to use under **Select Title**.

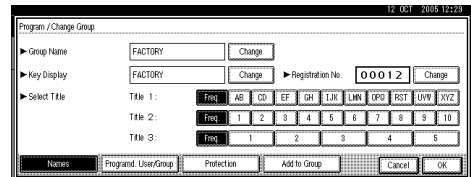

Note

- The keys you can select are as follows:
 - **[Freq.]**... Added to the page that is displayed first.
 - **[AB], [CD], [EF], [GH], [IJK], [LMN], [OPQ], [RST], [UVW], [XYZ], [1] to [10]**... Added to the list of items in the selected title.
- You can select **[Freq.]** and one more page for each title.

- 9 To continue registering the name, press [Continue to Program], and then repeat the procedure from step 6.
- 10 Press [OK].
- 11 Press [Exit].
- 12 Press the [User Tools/Counter] key.

Changing a Registered Name

- 1 Press the [User Tools/Counter] key.
- 2 Press [System Settings].
- 3 Press [Administrator Tools], and then press [▼Next].
- 4 Press [Address Book Management].
- 5 Select the registered name you want to change.

Press the name key, or enter the registered number using the number keys

Note

- If you press , you can search by the registered name, user code, fax number, folder name, e-mail address, or IP-Fax destination.

To change the name or key display

- 1 Press [Change] on the right of the name or key display.
- 2 Enter the name or key display, and then press [OK].

Reference

p.149 "Entering Text"

To change a registration number

- 1 Press [Change] to the right of "Registration No."
- 2 Enter a new registration number using the number keys, and then press [#].

To change the title

- 1 Press the key for the classification you want to use from Select Title.

6 Press [OK].

7 Press [Exit].

8 Press the [User Tools/Counter] key.

Deleting a Registered Name

If you delete a name, data associated with that name, such as e-mail addresses, fax number, folder name, and IP-Fax destination, is also deleted.

1 Press the [User Tools/Counter] key.

2 Press [System Settings].

3 Press [Administrator Tools], and then press [▼Next].

4 Press [Address Book Management].

5 Press [Delete].

6 Select the name you want to delete.

Press the key, or enter the registered number using the number keys

7 Press [Yes].

8 Press [Exit].

9 Press the [User Tools/Counter] key.

Authentication Information

Register user codes to limit users to the following functions and check their use of each function:

- Copier
- Document Server
- Facsimile
- Scanner
- Printer

Note

- ❑ The number of copies made of documents stored in the Document Server using the facsimile function is counted for each user code. This allows you to check each user's usage.
- ❑ The number of copies scanned using the scanner function is counted for each user code. This allows you to check each user's usage.
- ❑ To automatically register the printer driver user code, select **[Printer: PC Control]** for the printer in User Code Authentication. To use the user code set in User Tools, set the user codes registered in User Tools for the printer driver. See p.74 "Authentication Information".

Reference

For details about setting user codes for the printer driver, see *Printer Reference* or the printer driver Help.

Important

- ❑ The functions associated with each user code are the same. If you change or delete user codes, management data and limits associated with that code become invalid.

Registering a New User Code

- 1 Press the **[User Tools/Counter]** key.

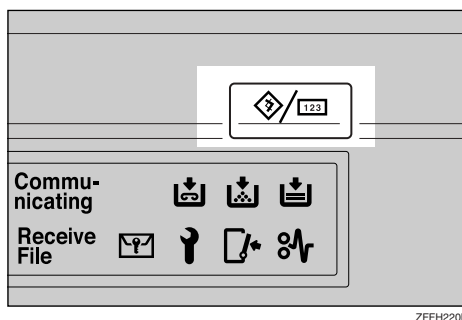

- 2 Press **[System Settings]**.

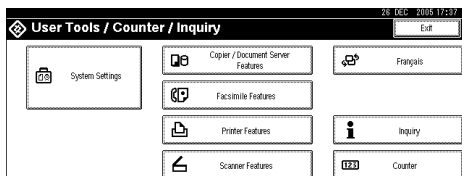

- 3 Press **[Administrator Tools]**, and then press **[▼Next]**.

- 4 Press **[Address Book Management]**.

- 5 Press the name whose code is to be registered, or enter the registered number using the number key.

Note

- ❑ You can enter a one-to eight-digit user code.
- ❑ To register the name, see p.72 "Registering Names".

- 6 Press **[Auth. Info]**.

- 7** Enter the user code using the number keys, and then press [#].

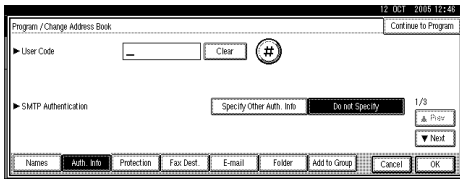

Note

- If you make a mistake, press [Clear] or the [Clear/Stop] key, and then enter the code again.

- 8** Press [▼Next] twice.

- 9** Select the functions to be used with the user code from Available Functions.

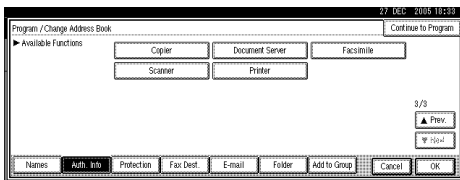

- 10** Press [OK].

Note

- To continue registering user codes, repeat the procedure from step 5.

- 11** Press [Exit].

- 12** Press the [User Tools/Counter] key.

Changing a User Code

Note

- Even if you change a user code, the counter value will not be cleared.

- 1** Press the [User Tools/Counter] key.

- 2** Press [System Settings].

- 3** Press [Administrator Tools], and then press [▼Next].

- 4** Press [Address Book Management].

- 5** Select the user whose user code you want to change.

Press the name key, or enter the registered number using the number keys

Note

- If you press [Search], you can search for a user by the registered name, user code, fax number, folder name, e-mail address, or IP-Fax destination.
- To change the name, key display and title, see p.73 "Changing a Registered Name".

- 6** Press [Auth. Info].

- 7** Press [Change], and then enter the new user code using the number keys

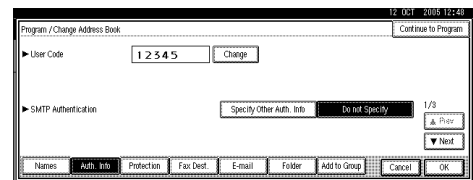

- 8** Press [#].

To change the available functions

- 1** Press [▼Next] twice.

- 2** Press the key to select the functions to enable them.

Note

- Press the key to highlight it, and then the function is enabled. To cancel a selection, press the highlighted key.

- 9** Press [OK].

- 10** Press [Exit].

- 11** Press the [User Tools/Counter] key.

Deleting a User Code

Note

- ❑ After clearing the user code, the counter is automatically cleared.
- ❑ To delete a name from the Address Book entirely, see p.73 “Deleting a Registered Name”.

- 1** Press the [User Tools/Counter] key.
- 2** Press [System Settings].
- 3** Press [Administrator Tools], and then press [▼Next].
- 4** Press [Address Book Management].
- 5** Select the name whose code is to be deleted.

Press the name key, or enter the registered number using the number keys

- 6** Press [Auth. Info].
- 7** Press [Change] to delete the user code, and then press [#].

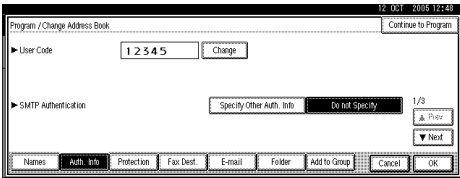

- 8** Press [OK].
- 9** Press [Exit].
- 10** Press the [User Tools/Counter] key.

Displaying the Counter for Each User Code

- 1** Press the [User Tools/Counter] key.
- 2** Press [System Settings].
- 3** Press [Administrator Tools].
- 4** Press [Display / Clear / Print Counter per User].
- 5** Select [Print Counter], [Transmission Counter] or [Scanner Counter].

Counters for individual function usage under each user code appear.

Printing the Counter for Each User Code

- 1** Press the [User Tools/Counter] key.
- 2** Press [System Settings].
- 3** Press [Administrator Tools].
- 4** Press [Display / Clear / Print Counter per User].
- 5** Select a user code from the left side of the display.

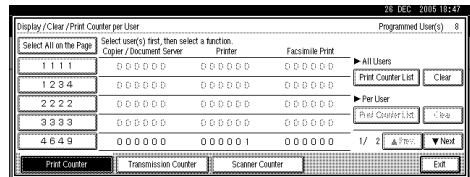

Note

- ❑ Press [Select All on the Page] to select all user codes on the page.

- 6** Press [Print Counter List] under Per User.

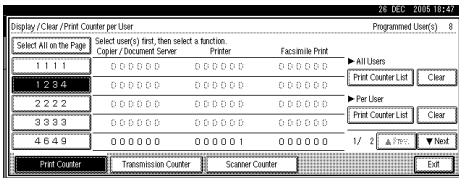

Note

- Enter the user code, and then press [#] if the user code is registered.

- 7** Select the function usage you want to print from [Print Counter], [Transmission Counter], and [Scanner Counter].

- 8** Press [Print].

To print the number of prints for all user codes

- 1** Press the [User Tools/Counter] key.
- 2** Press [System Settings].
- 3** Press [Administrator Tools].
- 4** Press [Display / Clear / Print Counter per User].
- 5** Press [Print Counter List] under All Users.

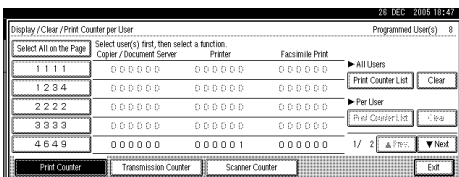

Note

- Enter the user code, and then press [#] if the user code is registered.

- 6** Select the function usage you want to print from [Print Counter], [Transmission Counter], and [Scanner Counter].

- 7** Press [Print].

Clearing the Number of Prints

- 1** Press the [User Tools/Counter] key.
- 2** Press [System Settings].
- 3** Press [Administrator Tools].
- 4** Press [Display / Clear / Print Counter per User].
- 5** Select the user code to clear.

To clear the number of prints made under a user code

- 1** Select the user code from the left side of the display.

Note

- Press [Select All on the Page] to select all user codes on the page.

- 2** Press [Clear] under Per User Codes.
- 3** Select the function usage you want to clear from [Print Counter], [Transmission Counter], and [Scanner Counter].
- 4** Press [OK].

To clear the number of prints for all user codes

1 Press [Clear] under All Users.

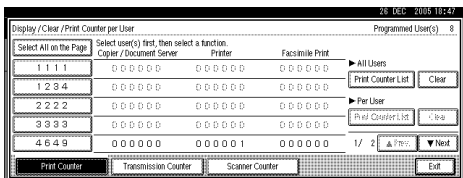

2 Select the function usage you want to clear from [Print Counter], [Transmission Counter], and [Scanner Counter].

3 Press [OK].

6 Press [Exit].

7 Press the [User Tools/Counter] key.

5

Fax Destination

Register a fax destination so you do not need to enter fax numbers each time, and can send documents that have been scanned in using the facsimile function.

For details about the number of fax destinations that can be registered, see *Facsimile Reference <Basic Features>*.

- It is easy to select the fax destination if you register "Name" and "Key Display" for the fax destination.
- You can register fax destinations by selecting them from redial function.
- You can register fax destinations as a group.

Registered Fax numbers can be used as sender's Fax numbers.

There are two types of fax destination, as shown below:

- Fax Destination
Select this to send the fax over the telephone network.
- IP-Fax
Select this to send the fax to a machine on a TCP/IP network.

📍 Limitation

- You cannot send the fax to a machine on another network if that network is behind a firewall.

❖ Fax Destination

You can program the following items in a fax destination:

- Fax number
Registers the destination's fax number. You can enter a fax number using up to 128 digits. You must include every digit in the number.

- SUB Code
Registering a SUB Code allows you to use Confidential Transmission to send messages to the other fax machines which support a similar function called "SUB Code". See "SUB Code", *Facsimile Reference <Advanced Features>*.
- SEP Code
Registering a SEP Code allows you to use Polling Reception to receive faxes from the other fax machines which support Polling Reception. See "SEP Code", *Facsimile Reference <Advanced Features>*.
- Line
If the optional extra G3 interface unit is installed, you can select the line type per destination.
- Fax header
You can select to print a fax header on fax messages the other party receives. The default is "1st Name". See *Facsimile Reference <Advanced Features>*.
- Label insertion
Use label insertion to print information such as the destination name on the sheet printed out at the destination. Data is printed as follows:
 - Destination Name: The destination name specified in [**Fax Destination**] is printed with "To" before it at the top of the sheet.
 - Standard Message: A registered two-line sentence is printed under "Destination Name".

Limitation

- ❑ To use this function, set Label Insertion to **[On]** when programming fax destinations and also select **[Programmed Name]** when sending fax documents.

Note

- ❑ Fax header and label insertion are also printed when sending by e-mail using the fax function.
- ❑ You can program a standard message other than those registered in the machine. See “Programming, Changing, and Deleting Standard Messages”, *Facsimile Reference <Advanced Features>*.

- International TX mode
When setting the International TX mode to **[On]**, the machine transmits more carefully by lowering transmission speed. However, communication times increase.

❖ **IP-Fax Destination**

You can program the following items in an IP-Fax Destination:

Note

- ❑ This setting only works if the IP fax function has been selected.
- IP-Fax
Register the IP-Fax destination. You can register the name using up to 128 characters. You must make this setting when using IP-Fax.

- SUB Code
Registering a SUB Code allows you to use Confidential Transmission to send messages to the other fax machines which support a similar function called “SUB Code”. See “SUB Code”, *Facsimile Reference <Advanced Features>*.
- SEP Code
Registering a SEP Code allows you to use Polling Reception to receive faxes from the other fax machines which support Polling Reception. See “SEP Code”, *Facsimile Reference <Advanced Features>*.
- Select Protocol
Select the protocol for the IP-Fax transmission.

Registering a Fax Destination

1 Press the **[User Tools/Counter]** key.

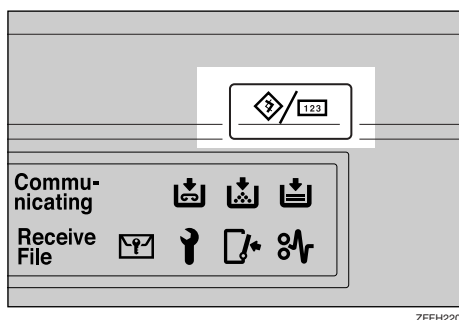

2 Press **[System Settings]**.

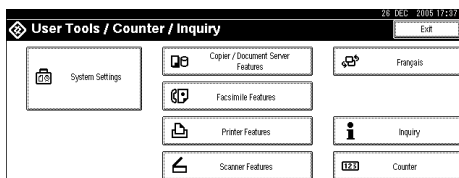

3 Press **[Administrator Tools]**, and then press **[▼Next]**.

4 Press **[Address Book Management]**.

- 5** Select the name whose fax destination you want to register.

Press the name key, or enter the registered number using the number keys.

 **Note**

- If you press **[OK]**, you can search by the registered name, user code, fax number, folder name, e-mail address, or IP-Fax destination.
- To register the name, key display, and title, see p.72 “Registering Names”.

- 6** Press **[Fax Dest.]**.

- 7** Enter the fax number using the number keys, and then press **[OK]** under Facsimile No..

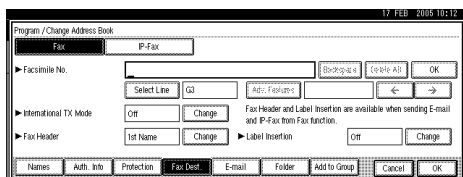

To select the line

- 1** Press **[Select Line]**.

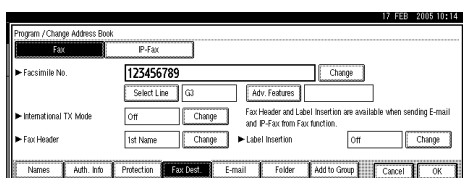

- 2** Select the line, and then press **[OK]**.

To program the SUB Code

- 1** Press **[Adv. Features]**, and then select **[SUB Code]**.
- 2** Press **[Change]** under TX SUB Code.

- 3** Enter a SUB Code using the number keys, and then press **[OK]**.

- 4** To enter a password, press **[Change]** under Password (SID).

- 5** Enter a password using the number keys, and then press **[OK]**.

- 6** Press **[OK]**.

To program the SEP Code

- 1** Press **[Adv. Features]**, and then select **[SEP Code]**.

- 2** Press **[Change]** under RX SEP Code.

- 3** Enter a SEP Code using the number keys, and then press **[OK]**.

- 4** To enter a password, press **[Change]** under Password (PWD).

- 5** Enter a password using the number keys, and then press **[OK]**.

- 6** Press **[OK]**.

To set the International TX Mode

- 1** Press **[Change]** under International TX Mode.

- 2** Select **[Off]** or **[On]**, and then press **[OK]**.

To select the fax header

 **Note**

- You can register the fax header in Program Fax Information in the system settings for Facsimile Features. See “Programming”, *Facsimile Reference <Basic Features>*.

- 1 Press [Change] under Fax Header.
- 2 Select [1st Name] or [2nd Name], and then press [OK].

To set label insertion

When Label Insertion is set to ON, the receiver's name and standard messages are printed on the fax message when it is received at the other end.

- 1 Press [Change] under Label Insertion.
- 2 Select [On].
- 3 Press [Change] under Line 2.
- 4 Select a standard message to print on the second line. To stamp a customized message, press [Custom Message].

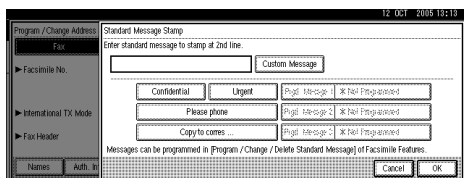

- 5 Enter a message, and then press [OK].

Reference

p.149 "Entering Text"

- 6 Press [OK].
- 7 Press [Change] under Line 3.
- 8 Select a standard message, and then press [OK].
- 9 Press [OK].

- 8 Press [OK].

Note

- When a group is registered, you can also add this fax destination to the group. See p.102 "Registering Names to a Group".

- 9 Press [Exit].

- 10 Press the [User Tools/Counter] key.

Changing a Registered Fax Destination

- 1 Press the [User Tools/Counter] key.
- 2 Press [System Settings].
- 3 Press [Administrator Tools], and then press [▼Next].
- 4 Press [Address Book Management].
- 5 Select the name whose fax destination you want to change.

Press the name key, or enter the registered number using the number keys.

Note

- If you press , you can search by the registered name, user code, fax number, folder name, e-mail address, or IP-Fax destination.
- To change the name, key display and title, see p.73 "Changing a Registered Name".

- 6 Press [Fax Dest.].

- 7 Change the settings.

To change the fax number

- 1 Press [Change] under Facsimile No..

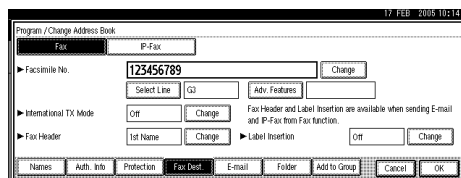

- 2 Enter the new fax number using the number keys, and then press [OK].

To change the line

- 1 Press **[Select Line]**.

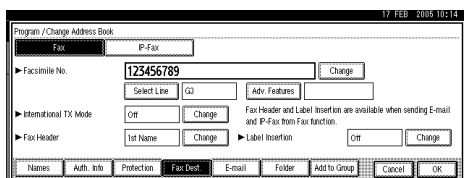

- 2 Select the line.
- 3 Press **[OK]**.

To change the SUB Code

- 1 Press **[Adv. Features]**.
- 2 Press **[SUB Code]**.
- 3 Press **[Change]** under TX SUB Code.
- 4 Enter the new SUB Code, and then press **[OK]**.
- 5 To change the password, press **[Change]** under Password (SID).
- 6 Enter the new password, and then press **[OK]**.
- 7 Press **[OK]**.

To change the SEP Code

- 1 Press **[Adv. Features]**.
- 2 Press **[SEP Code]**.
- 3 Press **[Change]** under RX SEP Code.
- 4 Enter the new SEP Code, and then press **[OK]**.
- 5 To change the password, press **[Change]** under Password (PWD).
- 6 Enter the new password, and then press **[OK]**.
- 7 Press **[OK]**.

To change the fax header

- 1 Press **[Change]** under Fax Header.
- 2 Select the new fax header, and then press **[OK]**.

To change the label insertion

- 1 Press **[Change]** under Label Insertion.
- 2 Press **[Change]** under Line 2.
- 3 Select the new standard message or press **[Custom Message]** to enter the new message.
- 4 Press **[OK]**.
- 5 Press **[Change]** under Line 3.
- 6 Select the new standard message, and then press **[OK]**.
- 7 Press **[OK]**.
- 8 Press **[OK]**.

 **Note**

- To change the name, key display and title, see p.73 "Changing a Registered Name".

- 9 Press **[Exit]**.

- 10 Press the **[User Tools/Counter]** key.

Deleting a Registered Fax Destination

 **Note**

- If you delete a destination that is a specified delivery destination, messages to its registered Personal Box, for example, cannot be delivered. Be sure to check the settings in the fax function before deleting any destinations.
- To delete a name entirely, see p.73 "Deleting a Registered Name".

- 1** Press the [User Tools/Counter] key.
- 2** Press [System Settings].
- 3** Press [Administrator Tools], and then press [▼Next].
- 4** Press [Address Book Management].
- 5** Select the name whose fax destination you want to delete.

Press the name key, or enter the registered number using the number keys.

 **Note**

- If you press , you can search by the registered name, user code, fax number, folder name, e-mail address, or IP-Fax destination.
- To delete the name, key display, and title, see p.73 “Deleting a Registered Name”.

- 6** Press [Fax Dest.].
- 7** Press [Change] under Facsimile No..
- 8** Press [Delete All], and then press [OK].

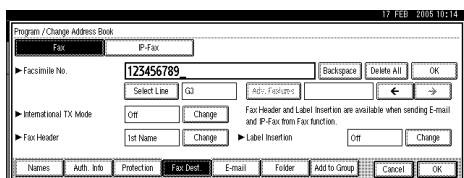

- 9** Press [OK].
- 10** Press [Exit].
- 11** Press the [User Tools/Counter] key.

Registering an IP-Fax Destination

 **Reference**

For details about sending an IP-Fax, see *Facsimile Reference* <Basic Features>.

- 1** Press the [User Tools / Counter] key.

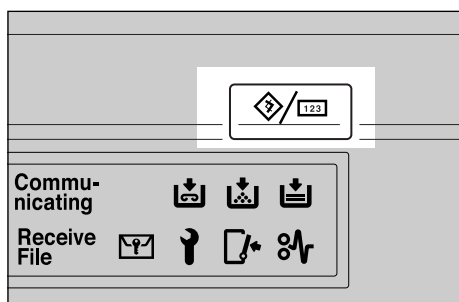

ZFFH220E

- 2** Press [System Settings].
- 3** Press [Administrator Tools], and then press [▼Next].
- 4** Press [Address Book Management].
- 5** Select the name whose IP-Fax destination you want to register.
Press the name key, or enter the registered number using the number keys.

 **Note**

- If you press , you can search by the registered name, user code, fax number, folder name, e-mail address, or IP-Fax destination.
- To register the name, key display, and title, see p.72 “Registering Names”.

- 6** Press [Fax Dest.].
- 7** Press [IP-Fax].

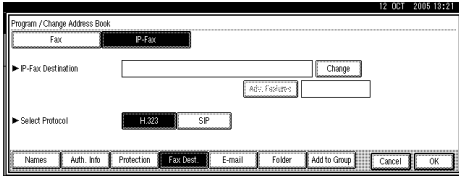
8 Press [Change].**9** Enter the IP-Fax destination and then press [OK].

To program the SUB Code

- 1** Press [Adv. Features], and then select [SUB Code].
- 2** Press [Change] under TX SUB Code.
- 3** Enter a SUB Code using the number keys, and then press [OK].
- 4** To enter a password, press [Change] under Password (SID).
- 5** Enter a password using the number keys, and then press [OK].
- 6** Press [OK].

To program the SEP Code

- 1** Press [Adv. Features], and then select [SEP Code].
- 2** Press [Change] under RX SEP Code.
- 3** Enter a SEP Code using the number keys, and then press [OK].
- 4** To enter a password, press [Change] under Password (PWD).
- 5** Enter a password using the number keys, and then press [OK].
- 6** Press [OK].

To select the protocol

- 1** Select [H.323] or [SIP].

10 Press [OK].

Changing a Registered IP-Fax Destination

- 1** Press the [User Tools / Counter] key.
- 2** Press [System Settings].
- 3** Press [Administrator Tools], and then press [▼Next].
- 4** Press [Address Book Management].

5 Select the name whose IP-Fax destination you want to change.

Press the name key, or enter the registered number using the number keys

Note

- If you press , you can search for a user by the registered name, user code, fax number, folder name, e-mail address, or IP-Fax destination.
- To change the name, key display and title, see p.73 "Changing a Registered Name".

6 Press [Fax Dest.].**7** Press [IP-Fax].**8** Change the settings.

To change the IP-Fax Destination

- 1** Press [Change] under IP-Fax Destination.
- 2** Enter the new destination using the number keys, and then press [OK].

To change the SUB Code

- 1 Press [Adv. Features].
- 2 Press [SUB Code].
- 3 Press [Change] under TX SUB Code.
- 4 Enter the new SUB Code, and then press [OK].
- 5 To change the password, press [Change] under Password (SID).
- 6 Enter the new password, and then press [OK].
- 7 Press [OK].

To change the SEP Code

- 1 Press [Adv. Features].
- 2 Press [SEP Code].
- 3 Press [Change] under RX SEP Code.
- 4 Enter the new SEP Code, and then press [OK].
- 5 To change the password, press [Change] under Password (PWD).
- 6 Enter the new password, and then press [OK].
- 7 Press [OK].

To change the protocol

- 1 Select [H.323] or [SIP].
- 9 Press [OK].

Deleting a Registered IP-Fax Destination

 **Note**

- If you delete a destination that is a specified delivery destination, messages to its registered Personal Box, for example, cannot be delivered. Be sure to check the settings in the fax function before deleting any destinations.
- To delete a name entirely, see p.73 "Deleting a Registered Name".

- 1 Press the [User Tools/Counter] key.
- 2 Press [System Settings].
- 3 Press [Administrator Tools], and then press [▼Next].
- 4 Press [Address Book Management].
- 5 Select the name whose IP-fax destination you want to delete. Press the name key, or enter the registered number using the number keys.

 **Note**

- If you press , you can search by the registered name, user code, fax number, folder name, e-mail address, or IP-Fax destination.
- To delete the name, key display, and title, see p.73 "Deleting a Registered Name".

- 6 Press [Fax Dest.].
- 7 Press [IP-Fax].
- 8 Press [Change] under Facsimile No..
- 9 Press [Delete All], and then press [OK].

10 Press [OK].

11 Press [Exit].

12 Press the [User Tools/Counter] key.

E-mail Destination

Register e-mail destinations so you do not need to enter an e-mail address every time, and can send scan files from scanner or fax function by e-mail.

- It is easy to select the e-mail destination if you register “Name” and “Key Display” as the e-mail destination.
- You can register e-mail destinations as a group.
- You can use the e-mail address as the sender's address when sending scan files in scanner mode. If you want to do this, set a protection code on the sender address to prevent unauthorized access. See p.107 “Registering a Protection Code”.

Note

- You can select an e-mail address from an LDAP server, and then register it in the Address Book. “Sending Scan File by E-mail”, *Scanner Reference*.
- You can set the machine to send a Transmission Result Report by e-mail whenever a transmission is sent. See *Facsimile Reference <Advanced Features>*.

Registering an E-mail Destination

- 1 Press the [User Tools/Counter] key.

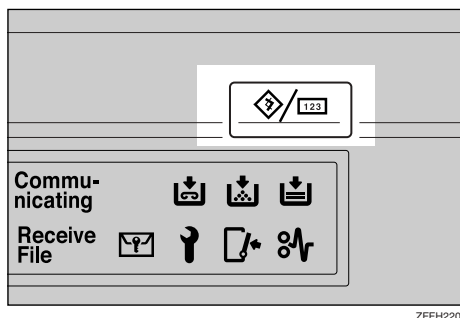

ZFFH220E

- 2 Press [System Settings].

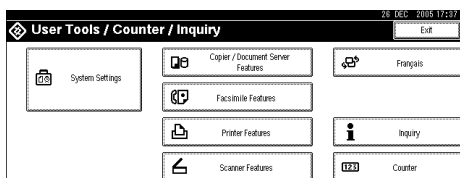

- 3 Press [Administrator Tools], and then press [▼Next].

- 4 Press [Address Book Management].

- 5 Select the name whose e-mail address you want to register.

Press the name key, or enter the registered number using the number keys.

Note

- If you press [E-mail], you can search by the registered name, user code, fax number, folder name, e-mail address, or IP-Fax destination.
- To register the name, key display, and title, see p.72 “Registering Names”.

- 6 Press [E-mail].

- 7** Press [Change] under E-mail Address.

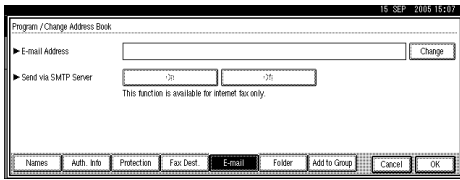

- 8** Enter the e-mail address, and then press [OK].

Note

- You can enter up to 128 characters for the e-mail address.

Entering the e-mail address

- 1** Enter the e-mail address.

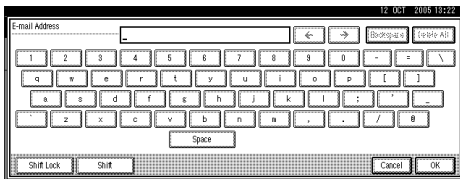

- 2** Press [OK].

Using the e-mail address as the sender

When an e-mail address is entered, it can be used as the sender's address.

- 1** Press [Protection].
2 Press [Sender] on the right side of Use Name as.

Reference

p.107 "Registering a Protection Code"

- 3** Press [OK].

- 9** If you want to use internet fax, specify whether or not to use "Send via SMTP Server".

- 10** Press [Exit].

- 11** Press the [User Tools/Counter] key.

Note

- When a group is registered, you can add the e-mail destinations to the group. See p.102 "Registering Names to a Group".

Changing a Registered E-mail Destination

- 1** Press the [User Tools/Counter] key.

- 2** Press [System Settings].

- 3** Press [Administrator Tools], and then press [▼Next].

- 4** Press [Address Book Management].

- 5** Select the name whose e-mail address you want to change.

Press the name key, or enter the registered number using the number keys

Note

- If you press , you can search by the registered name, user code, fax number, folder name, e-mail address, or IP-Fax destination.
- To change the name, key display, and title, see p.73 "Changing a Registered Name".

- 6** Press [E-mail].

- 7** Press [Change] under E-mail Address.

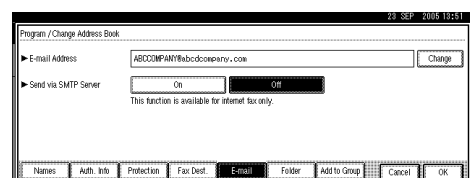

8 Enter the e-mail address, and then press [OK].

 **Reference**

p.149 "Entering Text"

9 Press [OK].

10 If you want to use internet fax, specify whether or not to use "Send via SMTP Server".

11 Press [Exit].

12 Press the [User Tools/Counter] key.

7 Press [Change] under E-mail Address.

8 Press [Delete All], and then press [OK].

9 Press [OK].

10 Press [Exit].

11 Press the [User Tools/Counter] key.

5

Deleting a Registered E-mail Destination

To delete a name entirely, see p.73 "Deleting a Registered Name".

1 Press the [User Tools/Counter] key.

2 Press [System Settings].

3 Press [Administrator Tools], and then press [▼Next].

4 Press [Address Book Management].

5 Select the name whose e-mail address you want to delete.

Press the name key, or enter the registered number using the number keys.

 **Note**

If you press , you can search by the registered name, user code, fax number, folder name, e-mail address, or IP-Fax destination.

To delete the name, key display, and title, see p.73 "Deleting a Registered Name".

6 Press [E-mail].

Registering Folders

By registering a shared folder, you can send scan files to it directly.

There are three types of protocol you can use:

- **SMB**
For sending files to shared Windows folders
- **FTP**
Use when sending files to an FTP server.
- **NCP**
Use when sending files to a NetWare server.

Note

- ❑ For details about protocols, server names, and folder levels, consult your network administrator.
- ❑ You can prevent unauthorized users from accessing folders from the machine. See p.107 "Registering a Protection Code".
- ❑ You can only select either SMB, FTP, or NCP. If you change protocol after finishing your settings, all previous entries are cleared.

Reference

For details about network settings, see "Setting Up the Machine on a Network", *Network Guide*.

For details about Scan to Folder, see "Sending Scan Files by Scan to Folder" *Scanner Reference*.

Using SMB to Connect

Note

- ❑ To register a folder in an FTP server, see p.95 "Using FTP to Connect".
- ❑ To register a folder in a NetWare server, see p.98 "Using NCP to Connect".

To register an SMB folder

- 1** Press the [User Tools/Counter] key.

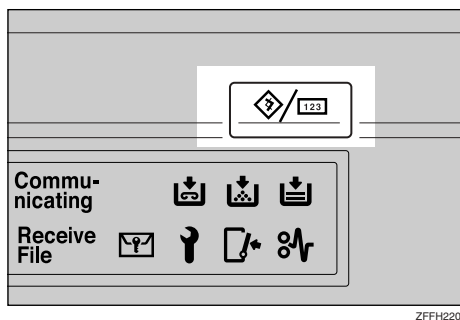

- 2** Press [System Settings].

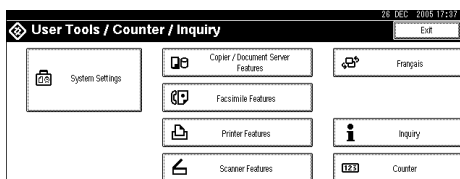

- 3** Press [Administrator Tools], and then press [▼Next].

- 4** Press [Address Book Management].

- 5** Select the name whose folder you want to register.

Press the name key, or enter the registered number using the number keys.

Note

- If you press , you can search by the registered name, user code, fax number, folder name, e-mail address, or IP-Fax destination.
- To register the name, key display, and title, see p.72 "Registering Names".

6 Press **[Auth. Info]**, and then press **[▼Next]**.

7 Press **[Specify Other Auth. Info]** on the right side of **Folder Authentication**.

Note

- When **[Do not Specify]** is selected, the SMB User Name and SMB Password that you have specified in Default User Name / Password (Send) of File Transfer settings applies. For details, see "User Tools Menu (System Settings)", *Network Guide*.
- If User Authentication is specified, contact your administrator.

8 Press **[Change]** under **Login User Name**.

9 Enter the login user name, and then press **[OK]**.

Note

- You can enter up to 64 characters for the user name.

Reference

p.149 "Entering Text"

10 Press **[Change]** under **Login Password**.

11 Enter the password, and then press **[OK]**.

Note

- You can enter up to 64 characters for the password.

12 Enter the password again to confirm, and then press **[OK]**.

13 Press **[Folder]**.

14 Confirm that **[SMB]** is selected.

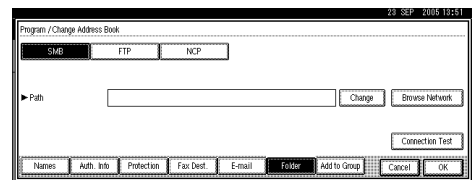

Note

- To specify a folder, you can either enter the path manually or locate the folder by browsing the network.

Reference

p.92 "To locate the folder manually"

p.93 "Using Browse Network to locate the folder"

To locate the folder manually

1 Press **[Change]** under **Path**.

2 Enter the path where the folder is located.

Note

- Enter the path using this format: "\\ServerName\ShareName\PathName".
- You can also enter an IP address.
- You can enter a path using up to 128 characters.

3 Press **[OK]**.

Note

- If the format of the entered path is not correct, a message appears. Press **[Exit]**, and then enter the path again.

Using Browse Network to locate the folder

1 Press [Browse Network].

The client computers sharing the same network as the machine appear.

Note

- If you have already specified your user name and password in steps **6** to **10**, the Browse Network display only lists client computers you are authorized to access.

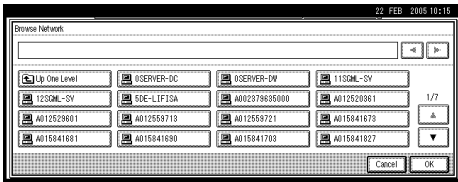
2 Select a client computer.

Shared folders under it appear.

Note

- You can press **[Up One Level]** to switch between levels.

3 Select the folder you want to register.

The Logon display appears.

Note

- If you have already entered an authorized user name and password, the Logon display will not appear. Proceed to step **6**.

4 Enter the user name.**Note**

- This is a user name which is authorized to access the folder.

5 Enter the user's password, and then press [OK].

The Browse Network display reappears.

Note

- If the entered user name or password is not correct, a message appears. Press **[Exit]**, and then enter the user name and password again.

6 Press [OK].**15 Press [Connection Test] to check the path is set correctly.****16 Press [Exit].****Note**

- If the connection test fails, check the settings, and then try again.

17 Press [OK].**18 Press [Exit].****19 Press the [User Tools/Counter] key.**

Changing a registered folder

1 Press the [User Tools/Counter] key.**2 Press [System Settings].****3 Press [Administrator Tools], and then press [▼Next].****4 Press [Address Book Management].**

5 Select the name whose folder you want to change.

Press the user name key, or enter the registered number using the number keys

Note

- If you press , you can search by the registered name, user code, fax number, folder name, e-mail address, or IP-Fax destination.
- To change the name, key display, and title, see p.73 "Changing a Registered Name".

6 Press [Folder].

7 Select the items you want to change.

To change the protocol

1 Press [FTP] or [NCP].

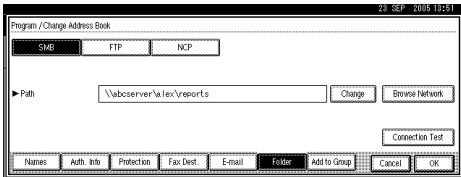

2 A confirmation message appears. Press [Yes].

Note

- Changing the protocol will clear all settings made under the previous protocol.

3 Enter each item again.

Reference

p.95 "To register an FTP folder".

p.98 "To register an NCP folder"

Changing items under SMB

1 Press [Change] under Path.

2 Enter the new path where the folder is located, and then press [OK].

Note

- You can also use Browse Network to specify a new folder. For details, see p.93 "Using Browse Network to locate the folder".

8 Press [Connection Test] to check the path is set correctly.

9 Press [Exit].

Note

- If the connection test fails, check the settings, and then try again.

10 Press [OK].

11 Press [Exit].

12 Press the [User Tools/Counter] key.

Deleting a registered folder

Note

- To delete a name entirely, see p.73 "Deleting a Registered Name".

1 Press the [User Tools/Counter] key.

2 Press [System Settings].

3 Press [Administrator Tools], and then press [▼Next].

4 Press [Address Book Management].

5 Select the name whose folder you want to delete.

Press the name key, or enter the registered number using the number keys.

Note

- If you press **[F5]**, you can search by the registered name, user code, fax number, folder name, e-mail address, or IP-Fax destination.
- To delete the name, key display, and title, see p.73 "Deleting a Registered Name".

6 Press **[Folder]**.

7 Press the protocol which is not currently selected.

A confirmation message appears.

8 Press **[Yes]**.

9 Press **[OK]**.

10 Press **[Exit]**.

11 Press the **[User Tools/Counter]** key.

Using FTP to Connect

Note

- To register a shared folder configured in Windows, see p.91 "Using SMB to Connect".
- To register a folder in an NetWare server, see p.98 "Using NCP to Connect".

To register an FTP folder

1 Press the **[User Tools/Counter]** key.

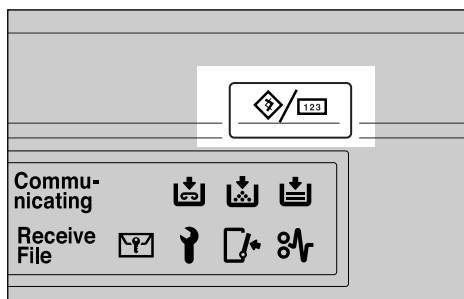

ZFFH220E

2 Press **[System Settings]**.

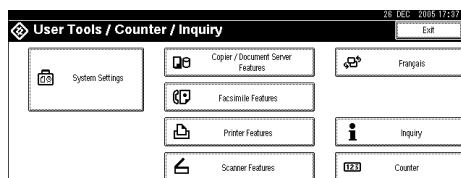

3 Press **[Administrator Tools]**, and then press **[▼Next]**.

4 Press **[Address Book Management]**.

5 Select the name whose folder you want to register.

Press the name key, or enter the registered number using the number keys.

Note

- If you press **[F5]**, you can search by the registered name, user code, fax number, folder name, e-mail address, or IP-Fax destination.
- To register the name, key display, and title, see p.73 "Deleting a Registered Name".

6 Press **[Auth. Info]**, and then press **[▼Next]**.

7 Press **[Specify Other Auth. Info]** on the right side of Folder Authentication.

Note

- When **[Do not Specify]** is selected, the SMB User Name and SMB Password that you have specified in Default User Name / Password (Send) of File Transfer settings applies. For details, see "User Tools Menu (System Settings)", *Network Guide*.
- If User Authentication is specified, contact your administrator.

8 Press **[Change]** under Login User Name.

9 Enter the login user name, and then press **[OK]**.

Note

- You can enter up to 64 characters for the user name.

Reference

p.149 "Entering Text"

10 Press **[Change]** under Login Password.

11 Enter the password, and then press **[OK]**.

Note

- You can enter up to 64 characters for the password.

12 Enter the password again to confirm, and then press **[OK]**.

13 Press **[Folder]**.

14 Press **[FTP]**.

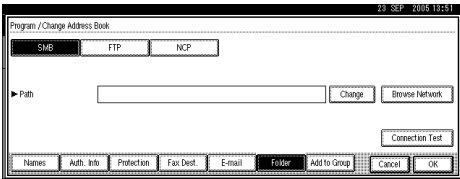

15 Press **[Change]** under Server Name.

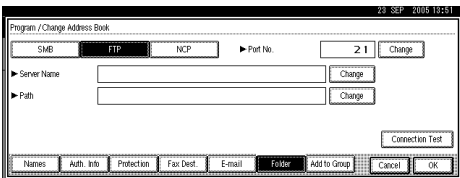

16 Enter the server name, and then press **[OK]**.

Note

- You can enter a server name using up to 64 characters.

17 Press **[Change]** under Path.

18 Enter the path.

Note

- You can enter an absolute path, using this format: "/user/home/username"; or a relative path, using this format: "directory/sub-directory".
- If you leave the path blank, the login directory is assumed to be the current working directory.
- You can also enter an IP address.
- You can enter a path using up to 128 characters.

19 Press **[OK]**.

Note

- To change the port number, press **[Change]** under Port No.. Enter the port number using the number keys, and then press **[#]**.
- You can enter 1 to 65535.

20 Press **[Connection Test]** to check the path is set correctly.

21 Press **[Exit]**.

Note

- If the connection test fails, check the settings, and then try again.

22 Press **[OK]**.

23 Press **[Exit]**.

24 Press the **[User Tools/Counter]** key.

Changing a registered folder

1 Press the **[User Tools/Counter]** key.

2 Press **[System Settings]**.

3 Press **[Administrator Tools]**, and then press **[▼Next]**.

4 Press [Address Book Management].

5 Select the name whose folder you want to change.

Press the name key, or enter the registered number using the number keys

 **Note**

- If you press , you can search for a user by the registered name, user code, fax number, folder name, e-mail address, or IP-Fax destination.
- To change the name, key display, and title, see p.73 “Changing a Registered Name”.

6 Press [Folder].

7 Select the items you want to change.

To change the protocol

1 Press [SMB], or [NCP].

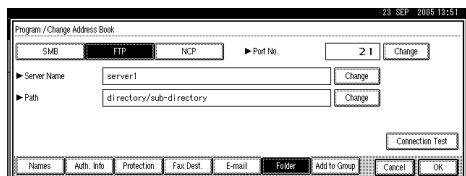

2 A confirmation message appears. Press [Yes].

 **Note**

- Changing the protocol will clear all settings made under the previous protocol.

3 Enter each item again.

 **Reference**

p.91 “To register an SMB folder”.

p.98 “To register an NCP folder”

Changing items under FTP

1 Press [Change] under Port No.

2 Enter the new port number, and then press [#].

3 Press [Change] under Server Name.

4 Enter the new server name, and then press [OK].

5 Press [Change] under Path.

6 Enter the new path, and then press [OK].

8 Press [Connection Test] to check the path is set correctly.

9 Press [Exit].

 **Note**

- If the connection test fails, check the settings, and then try again.

10 Press [OK].

11 Press [Exit].

12 Press the [User Tools/Counter] key.

Deleting a registered folder

 **Note**

- To delete a name entirely, see p.73 “Deleting a Registered Name”.

1 Press the [User Tools/Counter] key.

2 Press [System Settings].

3 Press [Administrator Tools], and then press [▼Next].

4 Press [Address Book Management].

5 Select the name whose folder you want to delete.

Press the name key, or enter the registered number using the number keys.

Note

- If you press **[Search]**, you can search by the registered name, user code, fax number, folder name, e-mail address, or IP-Fax destination.
- To delete the name, key display, and title, see p.73 "Deleting a Registered Name".

6 Press **[Folder]**.

7 Press the protocol which is not currently selected.
A confirmation message appears.

8 Press **[Yes]**.

9 Press **[OK]**.

10 Press **[Exit]**.

11 Press the **[User Tools/Counter]** key.

Using NCP to Connect

Note

- To register a shared folder configured in Windows, see p.91 "Using SMB to Connect"
- To register a folder in an FTP server, see p.95 "Using FTP to Connect"

To register an NCP folder

1 Press the **[User Tools/Counter]** key.

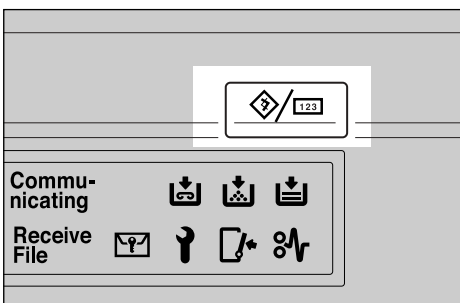

ZFFH220E

2 Press **[System Settings]**.

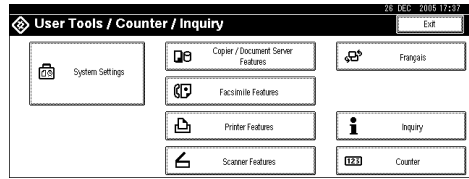

3 Press **[Administrator Tools]**, and then press **[▼Next]**.

4 Press **[Address Book Management]**.

5 Press the name you want to register or enter the registered number using the number keys.

Note

- To register a name in the Address Book, see p.72 "Registering a Name".

6 Press **[Auth. Info]**, and then press **[▼Next]**.

7 Press **[Specify Other Auth. Info]** on the right side of Folder Authentication.

Note

- When **[Do not Specify]** is selected, the SMB User Name and SMB Password that you have specified in Default User Name / Password (Send) of File Transfer settings applies. For details, see "User Tools Menu (System Settings)", *Network Guide*.

- If User Authentication is specified, contact your administrator.

8 Press **[Change]** under Login User Name.

9 Enter the login user name, and then press **[OK]**.

Limitation

- You can enter up to 64 characters for the user name.

Note

- ❑ If you have set "Connection Type" to **[NDS]**, enter the user name followed by the name of the context where the user object is located. If the user name is "user" and the context name is "context", enter "user.context"

Reference

p.149 "Entering Text"

10 Press **[Change]** under Login Password.

11 Enter the password, and then press **[OK]**.

Limitation

- ❑ You can enter up to 64 characters for the password.

12 Enter the password again to confirm, and then press **[OK]**.

13 Press **[Folder]**.

14 Press **[NCP]**.

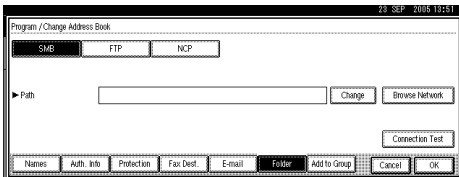

15 Select "Connection Type".

If you want to specify a folder in an NDS tree, press **[NDS]**. If you want to specify a folder on a NetWare server, press **[Bindery]**.

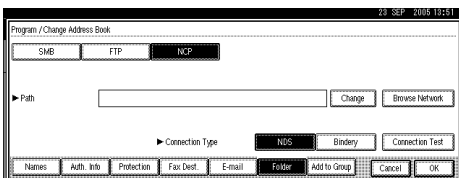

16 Specify the folder.

Note

- ❑ To specify a folder, you can either enter the path manually or locate the folder by browsing the network.

Reference

p.99 "To locate the folder manually"

p.100 "Using Browse Network to locate the folder"

To locate the folder manually

1 Press **[Change]** under Path.

2 Enter the path where the folder is located.

Note

- ❑ If you set "Connection Type" to **[NDS]**, and if the NDS tree name is "tree", the name of the context including the volume is "context", the volume name is "volume" and the folder name is "folder", then the path will be "\\tree\volume.context\folder".

- ❑ If you set "Connection Type" to **[Bindery]**, and if the NetWare server name is "server", the volume name is "volume" and the folder name is "folder", then the path will be "\\server\volume\folder".

- ❑ You can enter a path using up to 128 characters.

3 Press **[OK]**

4 Press **[Connection Test]** to check the path is set correctly.

5 Press **[OK]**.

Note

- ❑ If the connection test fails, check the settings, and then try again.

Using Browse Network to locate the folder

1 Press [Browse Network].

If you have set "Connection Type" to **[NDS]**, a list of items in the NDS tree appears.

If you have set "Connection Type" to **[Bindery]**, a list of items on the NetWare server appears.

Note

- Only the folders you are allowed to access appear in **[Browse Network]**.
- If the languages used on the machine and the destination you want to view differ, the items in the list may not appear correctly.
- Up to 100 items can be displayed in the list.

2 Search for the destination folder in the NDS tree or NetWare server.

Note

- You can press **[Up One Level]** to switch between levels.

3 Select the folder you want to register.

4 Press [OK].

17 Press [OK].

18 Press [Exit].

19 Press the [User Tools / Counter] key.

Changing a registered folder

1 Press the [User Tools/Counter] key.

2 Press [System Settings].

3 Press [Administrator Tools], and then press [▼Next].

4 Press [Address Book Management].

5 Select the user of the registered folder you want to change.

Press the name key, or enter the registered number using the number keys

Note

- If you press , you can search for a user by the registered name, user code, fax number, folder name, e-mail address, or IP-Fax destination.
- To change the name, key display, and title, see p.73 "Changing a Registered Name".

6 Press [Folder].

7 Select the items you want to change.

To change the protocol

1 Press [SMB] or [FTP].

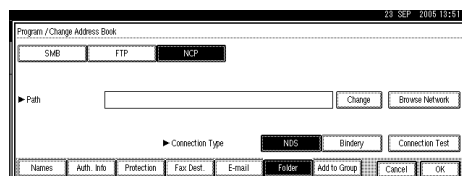

2 A confirmation message appears. Press [Yes].

Note

- Changing the protocol will clear all settings made under the previous protocol.

3 Enter each item again.

Reference

p.91 "To register an SMB folder".

p.95 "To register an FTP folder".

Changing items under NCP

- ❶ Select "Connection Type".
- ❷ Press [Change] under Path.
- ❸ Enter the new path where the folder is located, and then press [OK].

 **Note**

- You can also use Browse Network to specify a new folder. For details, see p.100 "Using Browse Network to locate the folder".

- ❸ Press [Connection Test] to check the path is set correctly.

- ❹ Press [Exit].

 **Note**

- If the connection test fails, check the settings, and then try again.

- ❺ Press [OK].

- ❻ Press [Exit].

- ❼ Press the [User Tools / Counter] key.

To delete the registered folder

 **Note**

- To delete a name entirely, see p.73 "Deleting a Registered Name".

- ❶ Press the [User Tools/Counter] key.

- ❷ Press [System Settings].

- ❸ Press [Administrator Tools], and then press [▼Next].

- ❹ Press [Address Book Management].

- ❺ Select a user of the folder you want to delete.

Press the name key, or enter the registered number using the number keys.

- ❻ Press [Folder].

- ❼ Press the protocol which is not currently selected.

A confirmation message appears.

- ❽ Press [Yes].

- ❾ Press [OK].

- ❿ Press [Exit].

- ⓫ Press the [User Tools / Counter] key.

Registering Names to a Group

You can register names to a group to enable easy management of e-mail addresses and folders for each group. To add names to a group, the groups must be registered beforehand.

Note

- You can register up to 100 groups.
- When using Scan to Folder function, you cannot send scan files to a group with over 50 folders registered.
- You can set a protection code to prevent unauthorized access to the folders registered in a group. For details, see p.107 "Registering a Protection Code".

5

5 Press [New Program].

6 Press [Change] under Group Name.

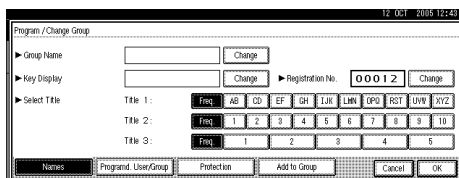

7 Enter the group name, and then press [OK].

The Key Display name is set automatically.

Reference

p.149 "Entering Text"

8 Press the title key under Select Title, if necessary.

Note

- The keys you can select are as follows:
 - [Freq.]... Added to the page that is displayed first.
 - [AB], [CD], [EF], [GH], [IJK], [LMN], [OPQ], [RST], [UVW], [XYZ], [1] to [10]... Added to the list of items in the selected title.
- You can select [Freq.] and one more page for each title.

9 When you want to change the key display, press [Change] under Key Display. Enter the key display, and then press [OK].

10 Press [OK].

11 Press [Exit].

12 Press the [User Tools/Counter] key.

Registering a New Group

1 Press the [User Tools/Counter] key.

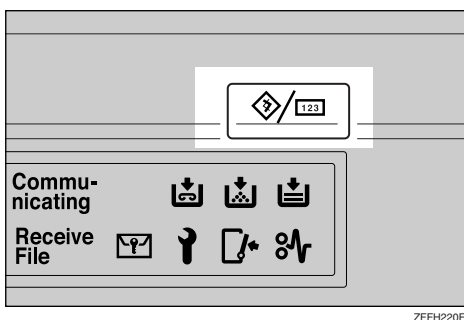

ZFFH220E

2 Press [System Settings].

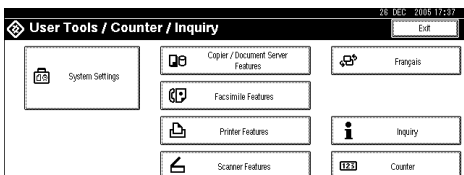

3 Press [Administrator Tools], and then press [▼Next].

4 Press [Address Book: Program / Change / Delete Group].

Registering Names to a Group

You can put names that have been registered in the Address Book into a group.

When registering new names, you can also register groups at the same time.

- 1** Press the [User Tools/Counter] key.
- 2** Press [System Settings].
- 3** Press [Administrator Tools], and then press [▼Next].
- 4** Press [Address Book Management].
- 5** Select the name to register in a group.

Press the name key, or enter the registered number using the number keys.

Note

- If you press , you can search by the registered name, user code, fax number, folder name, e-mail address, or IP-Fax destination.

- 6** Press [Add to Group].
- 7** Select a group to which you want to add the name to.

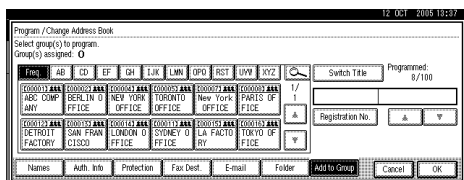

Note

- If you press , you can search for a group by entering the group name.

The group key that you have selected becomes highlighted, and the name is added to it.

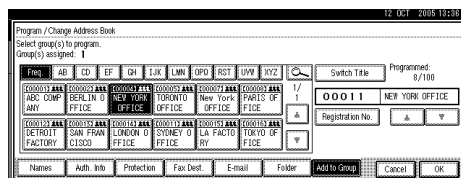

To remove the name, click the highlighted group again.

- 8** Press [OK].
- 9** Press [Exit].
- 10** Press the [User Tools/Counter] key.

Displaying Names Registered in Groups

You can check the names or groups registered in each group.

- 1** Press the [User Tools/Counter] key.
- 2** Press [System Settings].
- 3** Press [Administrator Tools], and then press [▼Next].
- 4** Press [Address Book: Program / Change / Delete Group].
- 5** Select the group where the members you want to check is registered.

- 6** Press [Programd. User/Group].

All the names registered will be displayed.

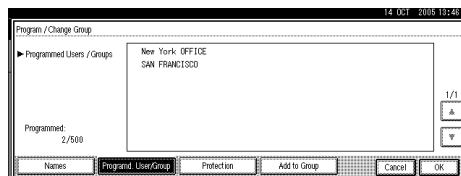

- 7** Press [OK].

8 Press [Exit].

9 Press the [User Tools/Counter] key.

Removing a Name from a Group

1 Press the [User Tools/Counter] key.

2 Press [System Settings].

3 Press [Administrator Tools], and then press [▼Next].

4 Press [Address Book Management].

5 Select the name to remove from a group.

Press the name key, or enter the registered number using the number keys.

6 Press [Add to Group].

7 Select the group from which you want to remove the name.

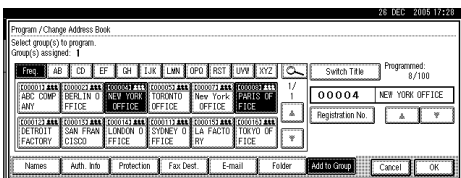

Note

□ Highlighted keys indicate groups in which the name has been registered.

The name is removed from the group.

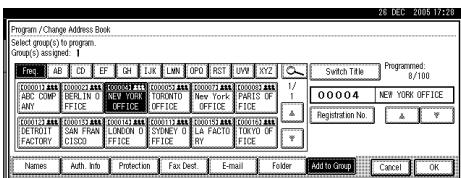

8 Press [OK].

9 Press [Exit].

10 Press the [User Tools/Counter] key.

Changing a Group Name

1 Press the [User Tools/Counter] key.

2 Press [System Settings].

3 Press [Administrator Tools], and then press [▼Next].

4 Press [Address Book: Program / Change / Delete Group].

5 Press the group key you want to change.

6 Enter the items.

To change the group name and key display

1 Press [Change] under Group Name or Key Display.

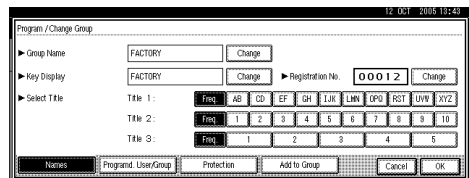

2 Enter the new group name or key display, and then press [OK].

To change the title

1 Press the title key under Select Title.

To change the registration number

1 Press [Change] under Registration No..

2 Enter the new registration number using the number keys.

3 Press [#].

- 7** Press [OK].
- 8** Press [Exit].
- 9** Press the [User Tools/Counter] key.

Deleting a Group

- 1** Press the [User Tools/Counter] key.
- 2** Press [System Settings].
- 3** Press [Administrator Tools], and then press [▼Next].
- 4** Press [Address Book: Program / Change / Delete Group].
- 5** Press [Delete].
- 6** Press a group key you want to delete.
- 7** Press [Yes].
- 8** Press [Exit].
- 9** Press the [User Tools/Counter] key.

Adding a Group to Another Group

You can add a group to another group.

- 1** Press the [User Tools/Counter] key.
- 2** Press [System Settings].
- 3** Press [Administrator Tools], and then press [▼Next].
- 4** Press [Address Book: Program / Change / Delete Group].
- 5** Select the group that you want to put into another group.

Press the group key, or enter the registered number using the number keys.

- 6** Press [Add to Group].
- 7** Select the group which you want to add to.

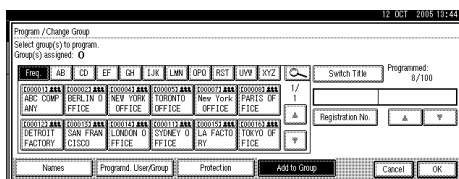

The group key that you have selected becomes highlighted, and the group is added to it.

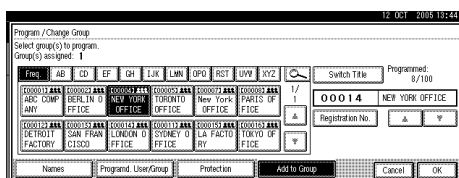

- 8** Press [OK].
- 9** Press [Exit].
- 10** Press the [User Tools/Counter] key.

Deleting a Group within a Group

- 1** Press the [User Tools/Counter] key.
- 2** Press [System Settings].
- 3** Press [Administrator Tools], and then press [▼Next].
- 4** Press [Address Book: Program / Change / Delete Group].
- 5** Within the group you want to delete.

Press the group key, or enter the registered number during the number keys.

- 6** Press [Add to Group].

The keys of groups in which the group is registered appear highlighted.

7 Select the group that you want to delete from.

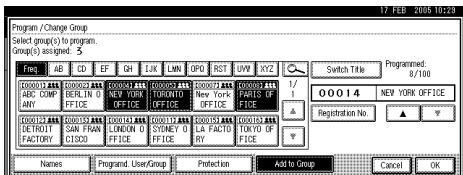

8 Press [OK].

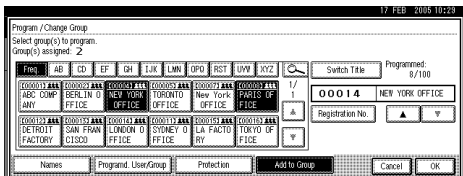

5 The group key is deselected and the group is deleted from it.

Registering a Protection Code

You can stop sender's names or folders being accessed by setting a protection code.

You can use this function to protect the following:

- Folders
You can prevent unauthorized access to folders.
- Sender's names
You can prevent misuse of sender's names.

Note

- To protect the mail sender's name, the user code must be registered in advance. For details, see p.74 "Authentication Information".

Registering a Protection Code To a Single User

1 Press the [User Tools/Counter] key.

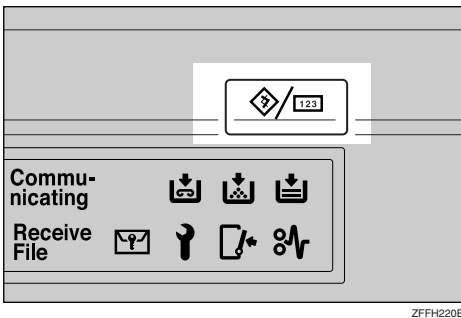

2 Press [System Settings].

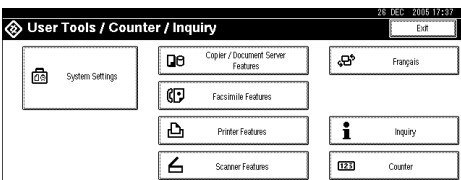

3 Press [Administrator Tools], and then press [▼Next].

4 Press [Address Book Management].

5 Select the name whose protection code you want to register.

Press the name key, or enter the registered number using the number keys.

Note

- If you press , you can search by the registered name, user code, fax number, folder name, e-mail address, or IP-Fax destination.
- To register the name, key display, and title, see p.72 "Registering Names".

6 Press [Protection].

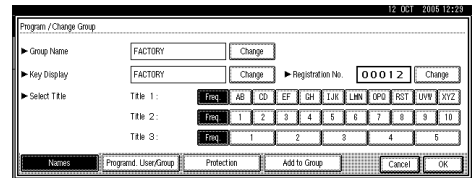

7 Press [Destination] or [Sender] under Use Name as.

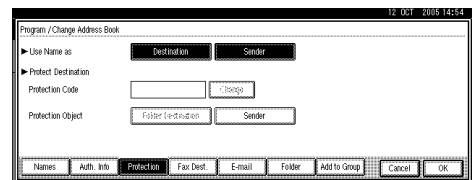

Note

- Both [Destination] and [Sender] can be selected at the same time.

8 Press [Folder Destination] or [Sender] under Protection Object.

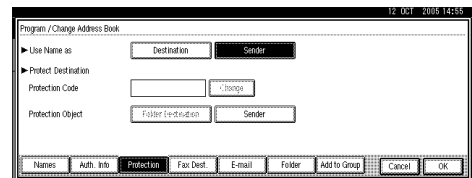

Note

- Both **[Folder Destination]** and **[Sender]** can be selected at the same time.

9 Press **[Change]** under **Protection Code**.

10 Enter a protection code using the number keys, and then press **[#]**.

Note

- By default, no protection code is specified.
- You can specify a protection code of up to eight digits. You can also specify "Protection" without specifying a protection code.

11 Press **[OK]**.

12 Press **[Exit]**.

13 Press the **[User Tools/Counter]** key.

Registering a Protection Code To a Group User

1 Press the **[User Tools/Counter]** key.

2 Press **[System Settings]**.

3 Press **[Administrator Tools]**, and then press **[▼Next]**.

4 Press **[Address Book: Program / Change / Delete Group]**.

5 Press the group key you want to register or enter the registered number using the number keys.

6 Press **[Protection]**.

7 Press **[Folder Destination]** under **Protection Object**.

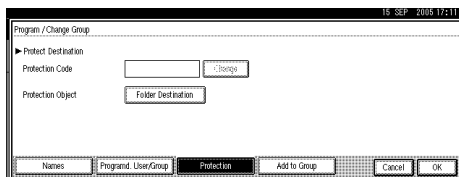

8 Press **[Change]** under **Protection Code**.

9 Enter a protection code using the number keys, and then press **[#]**.

Note

- By default, no protection code is specified.
- You can specify a protection code of up to eight digits. You can also specify "Protection" without specifying a protection code.

10 Press **[OK]**.

11 Press **[Exit]**.

12 Press the **[User Tools/Counter]** key.

Registering the Transfer Request

This section describes how to register the Transfer Station and Receiving Station used in the fax function's Transfer Request.

Note

- ❑ Before you can use Transfer Request, you must program the Polling ID and set the Transfer Report. See “Programming a Polling ID” and “Transfer Report”, *Facsimile Reference <Advanced Features>*.

❖ Transfer Station

Refers to the machine that receives the Transfer Request to forward incoming messages to another destination.

❖ Receiving Station

Refers to the facsimile or computer that receives messages from the Transfer Station.

! Limitation

- ❑ When messages are transferred by fax, Transfer Stations must be machines of the same manufacturer as this one, and have the Transfer Station function.
- ❑ When messages are transferred by e-mail, Transfer Stations must be machines of the same manufacturer as this one, and have both the Transfer Station and Internet Fax functions.
- ❑ You cannot use Transfer Request without programming the fax number or e-mail address of the Requesting Party in the Address Book of the Transfer Stations.

Note

- ❑ Polling IDs of the Requesting Party (this machine) and Transfer Stations must be identical.
- ❑ You can have up to 30 Receiving Stations per Transfer Station. If you specify a Transfer Station Group, the group counts as a single receiver.

Registering a Transfer Station/Receiving Station

- 1 Press the [User Tools/Counter] key.

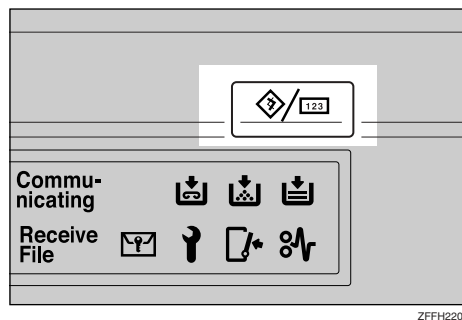

ZFFH220E

- 2 Press [System Settings].

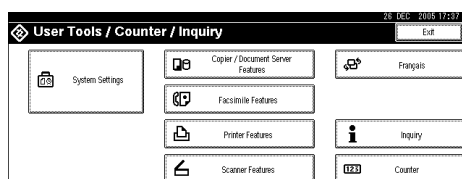

- 3 Press [Administrator Tools], and then press [▼Next].
- 4 Press [Address Book: Program / Change / Delete Transfer Request].
- 5 Press [New Program].

6 Set the Transfer Request's information.

To register the Transfer Request name and key display

1 Press [Change] under Transfer Request Name or Key Display.

The name entry display appears.

2 Enter the Transfer Request name or key display, and then press [OK].

Reference
p.149 "Entering Text"

To select the title

1 To associate a Transfer Request name with a title, press the title key under Select Title.

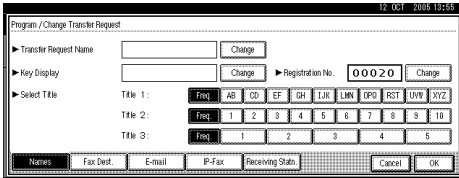

Note
 The keys you can select are as follows:

- [Freq.]... Added to the page that is displayed first.
- [AB], [CD], [EF], [GH], [IJK], [LMN], [OPQ], [RST], [UVW], [XYZ], [1] to [10]... Added to the list of items in the selected title.

You can select [Freq.] and one more page for each title.

7 Press [Fax Dest.].

8 Enter the items. See step **7** on p.80 "Registering a Fax Destination".

9 Press [E-mail].

10 Enter the items. See p.88 "Registering an E-mail Destination".

11 Press [IP-Fax].

12 Enter the items. See steps **9** - **10** on p.84 "Registering an IP-Fax Destination".

13 Press [Receiving Statn.].

14 Specify the Receiving Stations.

Note
 When specifying the Receiving Stations, use the numbers stored in Quick Dial keys, or Groups in the Transfer Station.

Quick Dial

1 Press [#Quick Dial].

2 Enter the number stored in the Quick Dial of the Transfer Station using the number keys

For example, to select the destination stored in Quick Dial 01 of the Transfer Station, enter [0][1].

3 To specify an additional Receiving Station, press [Add].

Speed Dial

1 Press [#*Speed Dial].

2 Enter the Speed Dial number using the number keys.

For example, to select the destination stored in Speed Dial 12 of the Transfer Station, enter [1][2].

Group Dial

- ① Press [**#** * * **Group Dial**].
- ② Enter the **Group number** using the number keys.

For example, to select the destinations stored in Group 04 of the Transfer Station, enter **[0][4]**.

- ③ To specify an additional Receiving Station, press [**Add**].
- ⑮ When you have specified all the Receiving Stations, press [**OK**].
- ⑯ Press [**Exit**].
- ⑰ Press the [**User Tools/Counter**] key.

Changing a Registered Transfer Station/Receiving Station

- ① Press the [**User Tools/Counter**] key.
- ② Press [**System Settings**].
- ③ Press [**Administrator Tools**], and then press [**▼Next**].
- ④ Press [**Address Book: Program / Change / Delete Transfer Request**].
- ⑤ Select the name whose Transfer Station/Receiving Station you want to change.

Press the name key, or enter the registered number using the number keys.

Note

- If you press , you can search by the group name, fax number, mail address, or IP-Fax destination.

- To change the name, key display, and title, see p.73 "Changing a Registered Name".

Note

- If you press , you can search for a user by Transfer Request name, fax number, or e-mail address.

⑥ Enter the items.

To change the Transfer Request name and key display

- ① Press [**Change**] under Transfer Request Name or Key Display.
- ② Enter the new Transfer Request Name or key display, and then press [**OK**].

To change the title

- ① Press the title key under Select Title.

To change the Fax Station

- ① Press [**Fax Dest.**].
Proceed to step ① of "To change the E-mail Transfer Station" when messages are transferred by e-mail.
- ② Change the Transfer Station's information. See p.82 "Changing a Registered Fax Destination".

To change the IP-Fax Station

- ① Press [**IP-Fax**].
- ② Change the Transfer Station's information. See step ③ on p.85 "Changing a Registered IP-Fax Destination".

To change the E-mail Transfer Station

- ① Press [E-mail].
- ② Change the Transfer Station's information. See steps 7 and 8 on p.89 "Changing a Registered E-mail Destination".

To change the Receiving Station

- ① Press [Receiving Statn.].
- ② Select the Receiving Station you want to change.
- ③ Press [Clear] to clear the number, and then enter the new number using the number keys.

7 Press [OK].

8 Press [Exit].

9 Press the [User Tools/Counter] key.

Deleting a Registered Transfer Station/Receiving Station

1 Press the [User Tools/Counter] key.

2 Press [System Settings].

3 Press [Administrator Tools], and then press [▼Next].

4 Press [Address Book: Program / Change / Delete Transfer Request].

5 Press [Delete].

6 Select the name whose Transfer Station/Receiving Station you want to delete.

Press the name key, or enter the registered number using the number keys.

 **Note**

- If you press , you can search by the group name, fax number, e-mail address, or IP-Fax destination.
- To delete the name, key display, and title, see p.73 "Deleting a Registered Name".

7 Press [Yes].

8 Press [Exit].

9 Press the [User Tools/Counter] key.

Registering Authentication

SMTP Authentication

For each user registered in the Address Book, you can register a login user name and login password to be used when accessing an SMTP server.

Reference

To use an SMTP server, you need to program it beforehand. For details, see “SMTP Server Settings”, *Network Guide*.

Note

- When **[Do not Specify]** is selected for SMTP Authentication, the User Name and Password that you have specified in SMTP Authentication of File Transfer settings applies. For details, see “User Tools Menu (System Settings)”, *Network Guide*.

- Press the **[User Tools/Counter]** key.

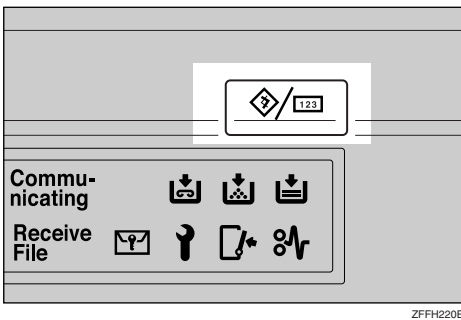

- Press **[System Settings]**.

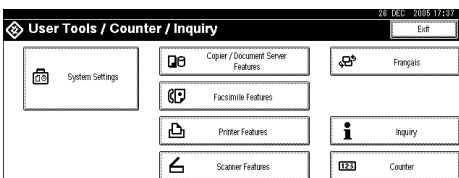

- Press **[Administrator Tools]**, and then press **[▼Next]**.

- Press **[Address Book Management]**.

- Press the name you want to register or enter the registered number using the number keys

Note

- To register a name in the Address Book, see p.72 “Registering Names”.

- Press **[Auth. Info]**.

- Press **[Specify Other Auth. Info]** Info on the right side of SMTP Authentication.

- Press **[Change]** under Login User Name.

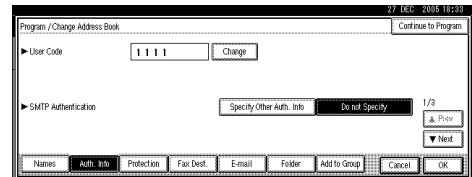

- Enter the login user name, and then press **[OK]**.

Note

- You can enter up to 64 characters for the user name.
- When using POP before SMTP Authentication, you can enter up to 63 alphanumeric characters.

Reference

p.149 “Entering Text”

- Press **[Change]** under Login Password.

- Enter the password, and then press **[OK]**.

Note

- You can enter up to 64 characters for the password.

12 Enter the password again to confirm, and then press [OK].

13 Press [OK].

Note

- To change the SMTP Authentication settings, repeat steps **8** to **13**.

LDAP Authentication

For each user registered in the Address Book, you can register a login user name and login password to be used when accessing an LDAP server.

Reference

To use an LDAP server, you need to program it beforehand. For details, see “LDAP Server Settings”, *Network Guide*.

Note

- When [Do not Specify] is selected for LDAP Authentication, the User Name and Password that you have specified in Program/Change LDAP Server of Administrator Tools settings applies. For details, see “Program / Change / Delete LDAP Server”, *Network Guide*.

1 Press the [User Tools/Counter] key.

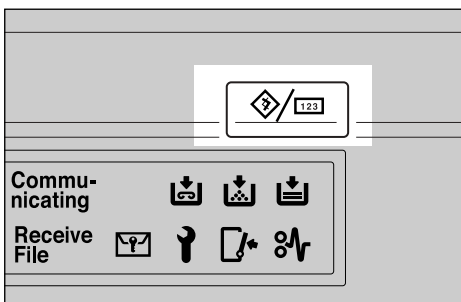

ZFFH220E

2 Press [System Settings].

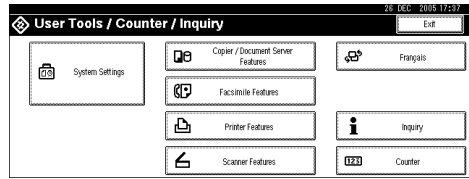

3 Press [Administrator Tools], and then press [▼Next].

4 Press [Address Book Management].

5 Press the name you want to register or enter the registered number using the number keys

Note

- To register a name in the Address Book, see p.72 “Registering Names”.

6 Press [Auth. Info], and then press [▼Next].

7 Press [Specify Other Auth. Info] on the right side of LDAP Authentication.

8 Press [Change] under Login User Name.

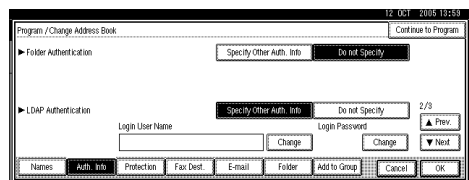

9 Enter the login user name, and then press [OK].

Note

- You can enter up to 64 characters for the user name.

Reference

p.149 “Entering Text”

10 Press [Change] under Login Password.

11 Enter the password, and then press [OK].

 **Note**

- You can enter up to 64 characters for the password.

12 Enter the password again to confirm, and then press [OK].

13 Press [OK].

 **Note**

- To change the LDAP Authentication settings, repeat steps **8** to **13**.

6. Troubleshooting

If Your Machine Does Not Operate As You Want

The following chart gives explanations of common problems and messages. If other messages appear, follow the instructions displayed.

Note

- ❑ If you cannot make copies as you want because of the paper type, paper size or paper capacity problems, use recommended paper. See p.162 “Copy Paper”.

General

Problem	Causes	Solutions
“Please wait.” appears	This message appears when you turn on the operation switch or change the toner bottle.	Wait for the machine to get ready.
Although the copier screen appears when the machine is turned on using the main power switch, it cannot be switched to another screen by pressing the [Facsimile] or [Scanner] key.	Functions other than the copier function are not yet ready.	Wait a little longer.
The machine has just been turned on and the User Tools screen is displayed, but the User Tools menu has items missing.	Functions other than the copier function are not yet ready. Time required varies by function. Functions appear in the User Tools menu when they become ready for use.	Wait a little longer.
The display is off.	The screen contrast knob is turned to the dark position.	Set the screen contrast knob to the light position to see the display panel properly.
	The machine is in Energy Saver mode.	Press the [Energy Saver] key to cancel Energy Saver mode.
	The operation switch is turned off.	Turn on the operation switch.
Nothing happens when the operation switch is turned on.	The main power switch is turned off.	Turn on the main power switch.

Problem	Causes	Solutions
Memory is full.	There are too many scanned pages or stored files: hard disk capacity is exceeded.	Press [Delete File] to delete unnecessary documents.
The function status indicator is red.	The function associated with the red indicator was interrupted.	Press the function key corresponding to the indicator. Follow the instructions that appear on the control panel.
You forgot your user code.	—	Contact your service representative.
The user code entry display appears.	Users are restricted by user management.	Enter the user code (up to 8 digits), and then press [#] .
The Authentication screen appears.	Basic Authentication, Windows Authentication, LDAP Authentication, or Integration Server Authentication is set.	Enter your login user name and user password. See p.24 “When the Authentication Screen is displayed”.
“You do not have the privileges to use this function.” is displayed.	The use of the function is restricted to authenticated users only.	Contact the administrator.
“You do not have the privileges to use this function.” continues to be displayed even though you have entered a valid user code.	This user code is not allowed to use the function selected.	Press the [Energy Saver] key. Check the display goes off, and then press the [Energy Saver] key again. The user code entry display returns. When printing under the copier or printer function, press [Energy Saver] only after printing has finished.
Authentication has failed.	The entered login user name or login password is not correct.	Inquire the user administrator for the correct login user name and login password.
	The machine cannot perform authentication.	Contact the administrator.
The selected file(s) which you do not have access privileges to could not be deleted.	You have tried to delete files without the authority to do so.	Files can be deleted by the person who created the file. To delete a file which you are not authorized to delete, contact the person who created the file.

Problem	Causes	Solutions
The main power indicator continues blinking and does not turn off when pressed.	This occurs in the following cases: <ul style="list-style-type: none"> • The exposure glass cover or the ADF is open. • The machine is communicating with external equipment. • The hard disk is active. 	Close the exposure glass cover or ADF, and check if the machine communicating with a computer.
Original images are printed on the reverse side of the paper.	You may have loaded the paper incorrectly.	Load paper correctly. Load paper into Tray 1-4 with the print side up, and into the LCT or bypass tray with the print side down. See p.123 "Orientation-Fixed Paper or Two-Sided Paper".
Misfeeds occur frequently.	The tray's side guides may not be locked.	Check the side guides are locked. See p.132 "Changing the Paper Size".
	The tray's end guide may not be set properly.	Check the end guide is set properly. See p.132 "Changing the Paper Size".
	You may have loaded paper of a size not shown on the paper size selector.	When using paper of a size that cannot be detected automatically, use Tray Paper Settings to set the paper size. See p.56 "Tray Paper Size: Tray 1-4" and p.162 "Copy Paper".
An error message remains, even if misfed paper is removed.	When a misfeed message appears, it remains until you open and close the cover, as required.	Clear misfed paper, and then open and close the front cover. See p.127 "Clearing Misfeeds".
An error message remains, even if consumables are replaced and/or misfed paper is removed.	This may occur if the HDD is not installed.	Press the [Start] key.
Cannot print in duplex mode.	You cannot use paper in the bypass tray for duplex printing.	For duplex printing, select Tray 1-4 in copier mode or with the printer driver.
	[1 Sided Copy] is selected for Paper Type: Tray 1-4.	Select [2 Sided Copy] for Paper Type: Tray 1-4. See p.58 "Paper Type: Tray 1-4"

Document Server

Problem	Solutions
"Scanned pages exceeded max. number. Do you want to store the scanned pages as a file?" appears.	<p>The number of scanned pages exceeds the capacity per file of the Document Server.</p> <p>To store scanned pages as a file, press [Store File]. Scanned data is stored as a file in the Document Server. If you do not want to store scanned pages, press [No]. Scanned data is deleted.</p>
You forgot your password.	Contact the administrator.
You cannot find out what is stored in a file.	<p>Check the date or time column in the Document Server: Select Files to Print display.</p> <p>Check document content by printing it's first page. Press the line of the document in the Document Server: Select Files to Print display, and then press [Print 1st Page] followed by the [Start] key.</p>
Memory frequently becomes full.	<p>Delete unnecessary files. On the file selection display, select unnecessary files, and then press [Delete]. If this does not increase available memory, do the following.</p> <ul style="list-style-type: none"> • Switch to the scanner display, and then delete unnecessary files stored under the scanner function. • Switch to the printer display, and then delete unnecessary files stored under Sample Print, Locked Print, Hold Print, or Stored Print.
You want to check print quality before making a large print run.	Check print quality by printing out only the first set using the [Sample Copy] key.
"Original is being scanned by another function." appears.	<p>The copier or scanner function is in use. To cancel a job in progress, first press [Exit], and then press the [Copy] key or [Scanner] key. Next, press the [Clear/Stop] key. When the message "[Stop] key was pressed." appears, press [Stop].</p>

☰ Loading Paper

🔍 Reference

For paper types and sizes, see p.162 “Copy Paper”.

Loading Paper into Paper Trays

📌 Note

- ☐ You can change the paper size, see p.132 “Changing the Paper Size”.

1 Pull out the paper tray until it stops.

2 Square the paper and load it in the tray with the copying face up.

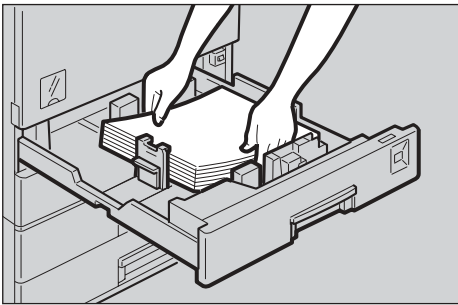

ZEWY100E

⚠️ Important

- ☐ If you add paper to a paper tray with paper left inside, a misfeed might occur.
- ☐ Do not stack paper over the limit mark.
- ☐ When loading small quantities of paper, be careful not to squeeze the side guide in too tightly, as the paper will not feed properly.

Setting special paper in the paper tray 2

1 Load the special paper below the limit mark of the tray.

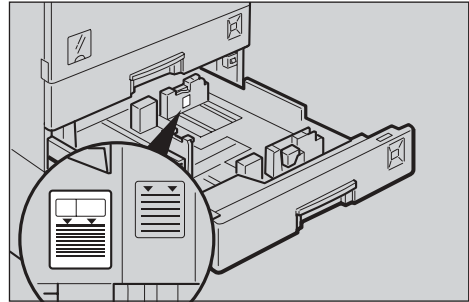

ZEWY110E

📌 Note

- ☐ Fan the paper before loading.
- ☐ When using paper such as translucent paper, straighten curled or warped paper before loading.

3 Push the paper tray in until it stops.

Loading Paper into Large Capacity Tray (optional)

Note

- Load copy paper of the same size and orientation in both left and right side trays.

1 Pull out the LCT.

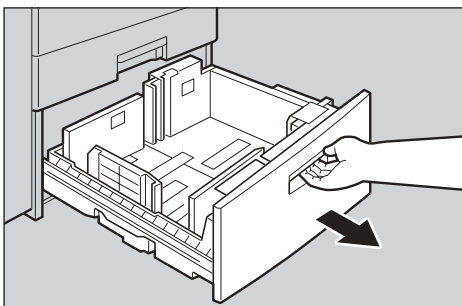

ZEWY010E

2 Square the paper, and then load it in the tray with the copying face up.

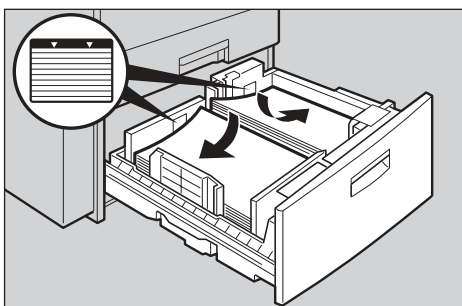

ZEWY020E

Important

- Align the right edge of the right copy paper stack with the right edge of the tray.
- Align the left edge of the left copy paper stack with the left edge of the tray.
- Do not stack paper over the limit mark.







Note

- Fan the paper before loading.
- Straighten curled or warped paper before loading.

3 Push the paper tray in until it stops.

Orientation-Fixed Paper or Two-Sided Paper

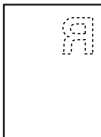
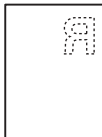
Orientation-fixed (top to bottom) or two-sided paper (for example, letterhead paper, punched paper, or copied paper) might not print correctly, depending on how the originals and paper are placed. Select **[Yes]** in Letterhead Setting under Copier/Document Server Features, and then place the original and paper as shown below (see *Copy Reference*). When printing with the printer function, placing orientation is the same.

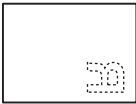
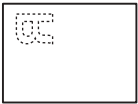
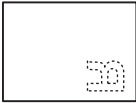
Copy Mode		Paper Tray	LCT	Bypass Tray	
				Original on the exposure glass	Original on the ADF
Paper placing direction 	1 Sided				
	2 Sided			—	—
Paper placing direction 	1 Sided		—		
	2 Sided		—	—	—

GEWH100E

Adding Toner

When  appears, it is time to add toner.

WARNING:

- **Do not incinerate used toner or toner containers. Toner dust might ignite when exposed to an open flame. Dispose of used toner containers in accordance with local regulations.**

CAUTION:

- *Keep toner (used or unused) and toner containers out of reach of children.*

CAUTION:

- *If toner or used toner is inhaled, gargle with plenty of water and move into a fresh air environment. Consult a doctor if necessary.*

CAUTION:

- *If toner or used toner gets into your eyes, flush immediately with large amounts of water. Consult a doctor if necessary.*

CAUTION:

- *If toner or used toner is swallowed, dilute by drinking a large amount of water. Consult a doctor if necessary.*

CAUTION:

- *Avoid getting toner on your clothes or skin when removing a paper jam or replacing toner. If your skin comes into contact with toner, wash the affected area thoroughly with soap and water.*
- *If toner gets on your clothing, wash with cold water. Hot water will set the toner into the fabric and may make removing the stain impossible.*

Important

- Fault may occur if you use toner other than the recommended type.
- When adding toner, do not turn off the operation switch. If you do, settings will be lost.
- Always add toner when the machine instructs you.
- Do not repeatedly install and remove toner bottles. This will result in toner leakage.
- Do not shake the removed toner bottle. Remaining toner might scatter.

Note

- You can make about 50 copies even after the “ Toner is almost empty.” and “Replace Toner Bottle.” messages appear, but replace toner early to prevent poor copy quality.

Reference

For details about toner storage, see p.142 “Toner Storage”.

Removing Toner

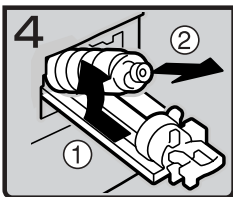
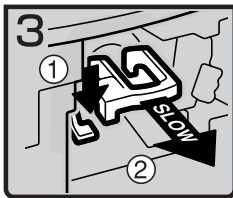
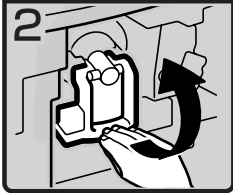

- 1: Open the front cover of the machine.
- 2: Raise the toner holder lever.
- 3: Push the green lever, and then gently pull out the holder.
- 4: Push the toner bottle back to raise its top, and then gently pull out the bottle.

Inserting Toner

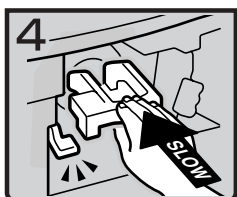
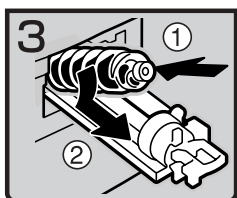
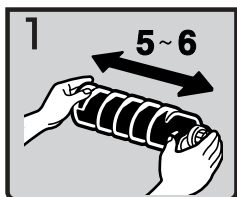

- 1: Hold the new bottle horizontally and shake it from side to side five or six times.

 **Note**

- Do not remove the black cap before shaking.

- 2: Remove the black cap.

 **Note**

- Do not remove the inner cap.

- 3: Put the toner bottle on the holder, and then pull its top forward.

- 4: Push in the green lever until it clicks.

 **Note**

- Before lowering the toner holder lever, be sure to push the toner holder fully in.

- 5: Lower the toner holder lever back into its original position.

- 6: Close the machine's front cover.

Clearing Misfeeds

CAUTION:

- *The fusing section of this machine might be very hot. Caution should be taken when removing misfed paper.*

Important

- When clearing misfeeds, do not turn off the operation switch. If you do, your copy settings will be lost.
- To prevent misfeeds, do not leave any torn scraps of paper inside the machine.
- If paper misfeeds occur frequently, contact your service representative.

Note

- More than one misfed area may be indicated. When this happens, check all the areas indicated. See the following charts: A, B, C, D, P, R, Y, Z
- Inside the finisher, or inside the front cover, there is a sticker explaining how to remove misfed paper.

■ When D is lit

1. Open the bypass tray, and then open the duplex unit.
2. Open the right cover, and then open the upper right cover.
3. Remove the misfed paper.
4. If you cannot remove the misfed paper, open the top cover of the bridge unit.
5. Remove the misfed paper. 6. Close the cover.
7. If you cannot remove the misfed paper, open the right cover of the bridge unit.
8. Remove the misfed paper. 9. Close the cover.

6

■ When B is lit

1. Open the bypass tray, and then open the duplex unit.
2. Open the right cover, and then open the upper right cover.
3. Remove the misfed paper.
4. Push up the paper guide release lever, and then remove the misfed paper. 5. Pull down the paper guide release lever, and then close the bypass tray.

■ When A is lit

1. Open the upper right cover.
2. Remove the misfed paper.

When C is lit

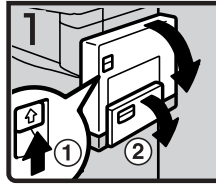

1. Open the bypass tray, and then open the duplex unit.

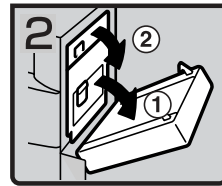

2. Open the right cover, and then open the upper right cover

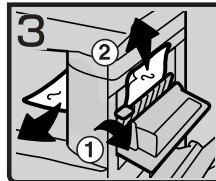

3. Remove the misfed paper.

! Important
A paper jam warning will not be cleared until the covers ①, ② are opened and the operation switch is set to ON.

4. Close the cover.

5. Close the duplex unit and front cover.

If you still cannot remove misfed paper
Contact your service representative.

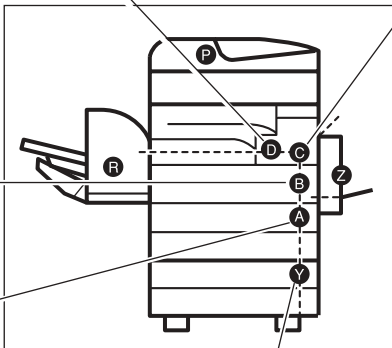

When Y is lit

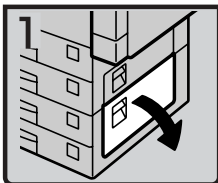

1. Open the right cover.

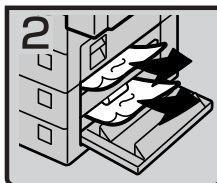

2. Remove the misfed paper.
3. Close the cover.

You can make an enlarged copy of this page and stick it on walls in the proximity of the machine.

ZLFX260E

■ When P is lit



1. Open the cover of the auto document feeder (ADF), and then remove the misfed original.

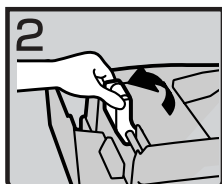

2. Lift the lever.

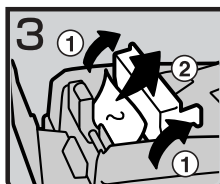

3. Open the cover, and then remove the misfed original.



4. If you cannot remove the misfed original, open the ADF external cover, and then remove the misfed original.

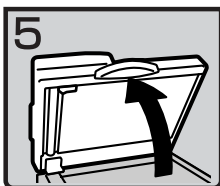

5. Open the auto document feeder (ADF).

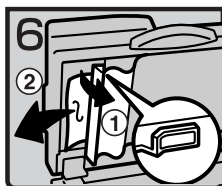

6. Pull the green lever in the upper left corner, and then remove the misfed original.

6

■ When R is lit

1000-sheet finisher

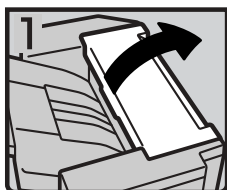

1. Open the upper cover.



2. Remove the misfed paper.

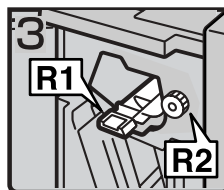

3. Open the front cover.

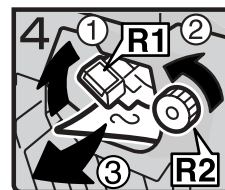

4. Hold up lever R1, turn knob R2, and then remove the misfed paper.

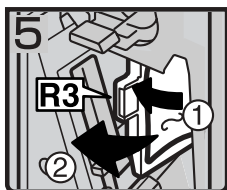

5. Open lever R3 to the left, and then remove the misfed paper.

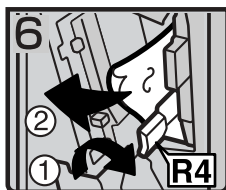

6. Push lever R4 to the right, and then remove the misfed paper.

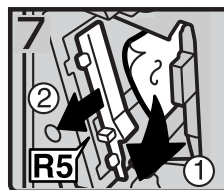

7. Pull lever R5, and then remove the misfed paper.

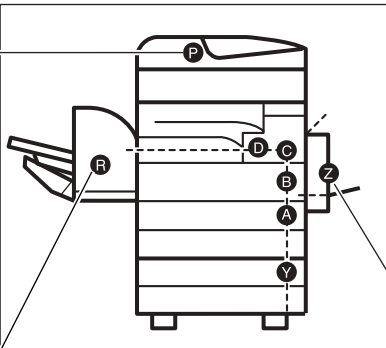

■ When Z is lit

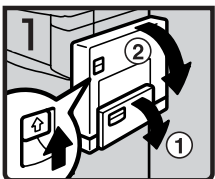

1. Open the duplex unit.

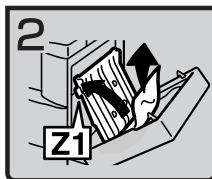

2. Raise cover Z1, and then remove the misfed paper.

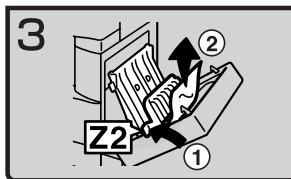

3. If you cannot remove the misfed paper, raise cover Z2, and then remove any that is there.
4. Close the unit.

500-sheet finisher

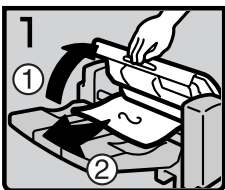

1. Open the upper cover, and then remove the misfed paper.

You can make an enlarged copy of this page and stick it on walls in the proximity of the machine

Changing the Paper Size

Preparation

Be sure to select the paper size with User Tools and the paper size selector. If you do not, misfeeds might occur. See p.56 “Tray Paper Size: Tray 1–4”.

Important

- If you want to change the paper size set in the LCT, contact your service representative.

Reference

For details about paper sizes and types, see p.162 “Copy Paper”.

4 Release the side lever.

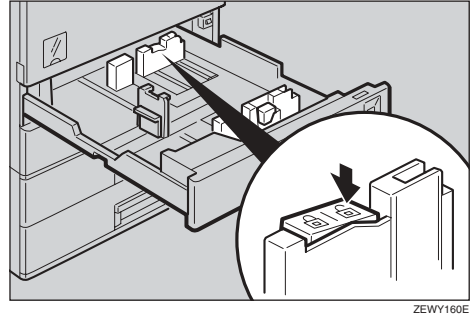

5 While pressing the release lever, adjust the side guides.

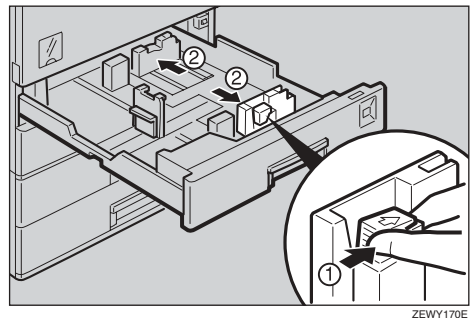

6 Square the paper, and then load it in the tray with the copying face up.

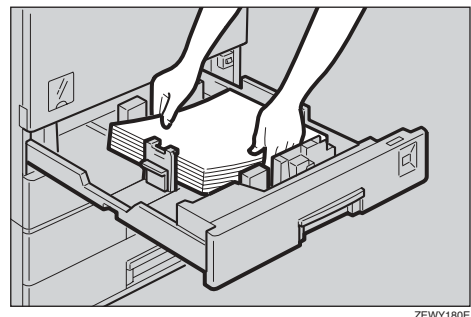

Changing the Paper Size of the Paper Tray

1 Make sure the paper tray is not in use. Then, pull the paper tray out slowly.

2 If paper is loaded in the tray, remove it.

3 While pressing the release lever, adjust the back guide.

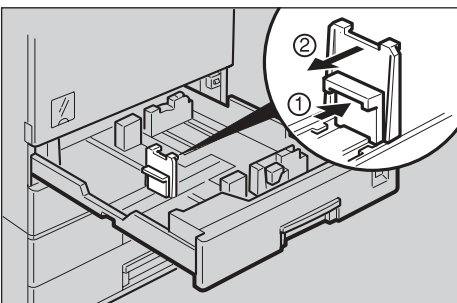

Important

- Do not stack paper over the limit mark.
- Make sure the paper stack is flush against the right side guide.

Note

- Fan the paper before loading.
- Straighten curled or warped paper before loading.

- 7** While pressing the release lever, adjust the side guides to the new paper size.

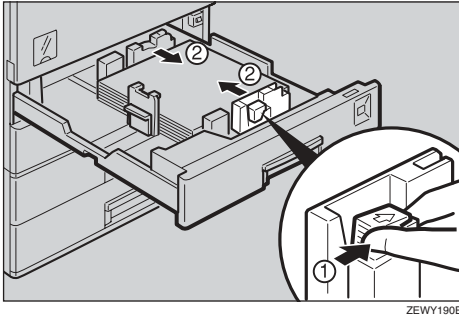

ZEWY190E

Important

- When loading small quantities of paper, be careful not to squeeze the side guide in too tightly, as the paper will not feed properly.

- 8** Lock the side lever.

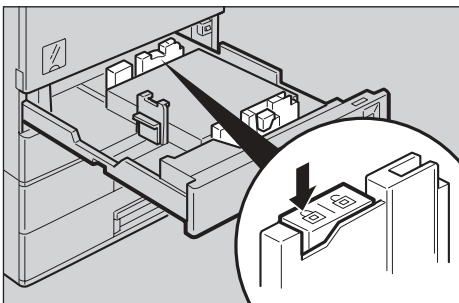

ZEWY200E

- 9** While pressing the release lever, adjust the back guide to the new paper size.

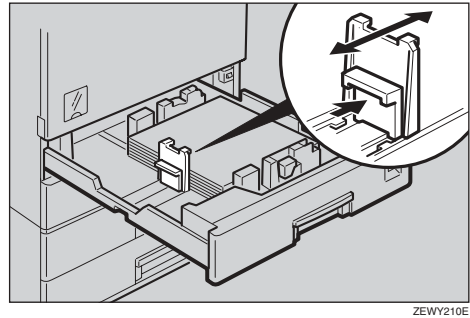

ZEWY210E

- 10** Adjust the paper size selector to the new paper size.

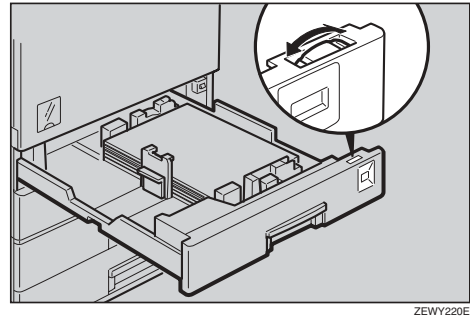

ZEWY220E

To adjust the paper size to a size not indicated on the paper size selector

- 1** Set the paper size selector to the * mark.
- 2** Press the [User Tools/Counter] key.
- 3** Press [System Settings].
- 4** Press [Tray Paper Settings].
- 5** Press [Tray Paper Size: Tray 1], [Tray Paper Size: Tray 2], [Tray Paper Size: Tray 3] or [Tray Paper Size: Tray 4].
- 6** Select the required size, and then press [OK].
- 7** Press [Exit] or the [User Tools/Counter] key to exit User Tools.

 **Reference**

p.56 "Tray Paper Size: Tray
1-4"

- 11** Gently push the paper tray in until it stops.
- 12** Check the paper size shown on the display panel.

Adding Staples

Important

- ❑ Stapling failures or jams may occur if you use a staple cartridge other than that recommended.

Reference

For details about the type of finisher, see p.19 “External Options”.

500-Sheet Finisher

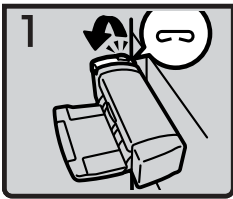

ZEWJ000E

- 1: Open the side cover.

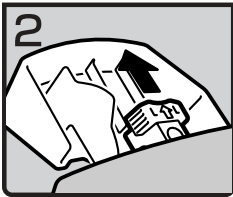

ZEWJ010E

- 2: Remove the cartridge.

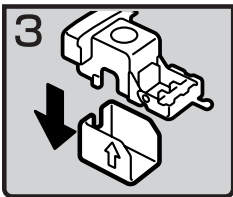

ZEWJ020E

- 3: Take out the empty refill in the direction of the arrow.

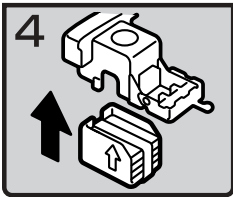

ZEWJ030E

- 4: Push in the new refill until it clicks.

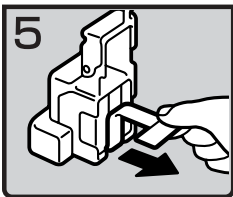

ZEWJ040E

- 5: Pull out the ribbon.

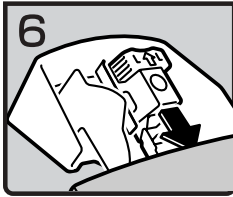

ZEWJ050E

- 6: Reinstall the cartridge.
- 7: Close the side cover.

1000-Sheet Finisher

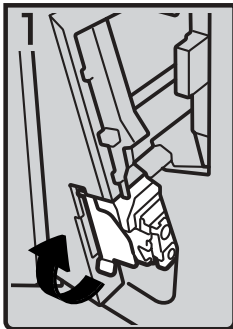

ZGJS801E

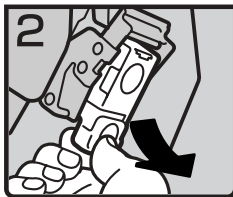

ZGJS802E

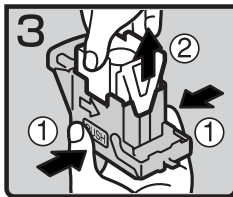

ZGJS803E

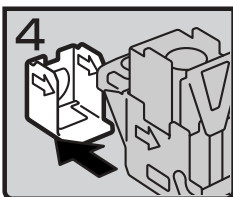

ZGJS804E

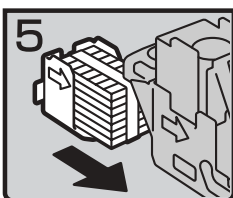

ZGJS805E

- 1: Open the front cover of the finisher, and then pull out the staple unit.

- 2: Hold the green lever, and then gently pull out the cartridge.

- 3: Hold both sides of the cartridge.
- 4: Pull up the upper unit of the cartridge.

- 5: Take out the empty refill in the arrow direction.

- 6: Align the arrows on the new refill with those on the cartridge, and then push in the refill until it clicks.

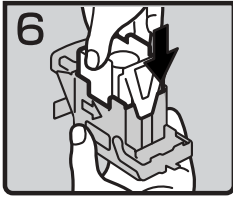

ZGJS806E

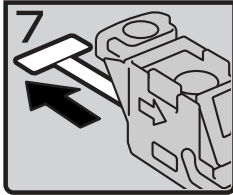

ZGJS807E

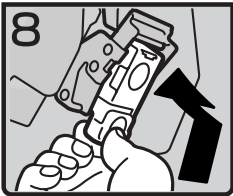

ZGJS808E

- 7: Gently push down the upper unit into the cartridge.
- 8: Pull out the ribbon.
- 9: Hold the green lever while pushing in the cartridge until it clicks.
- 10: Push back the staple unit, and then close the front cover of the finisher.

Removing Jammed Staples

Note

- ❑ Curled paper may cause staples to jam. To avoid this, turn copy paper over in the tray. If there is no improvement, change to a stiffer copy paper.
- ❑ When the 500-sheet finisher is installed, after removing jammed staples, staples will not be ejected the first few times you try to use the stapler.

Reference

For types of finisher, see p.19 “External Options”.

500-Sheet Finisher

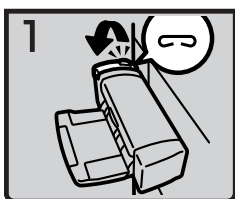

- 1: Open the side cover.

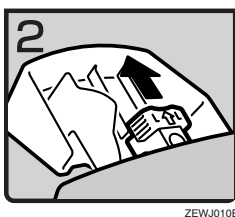

- 2: Remove the cartridge.

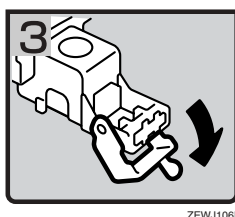

- 3: Open the face plate.

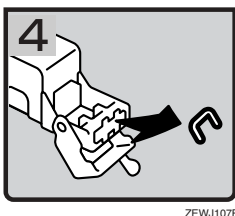

- 4: Remove the jammed staples.

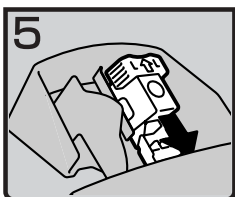

- 5: Reinstall the cartridge.
- 6: Close the side cover.

1000-Sheet Finisher

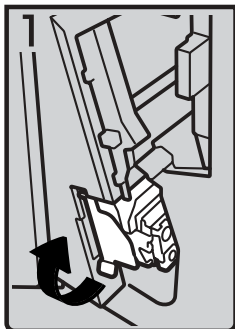

ZGJS801E

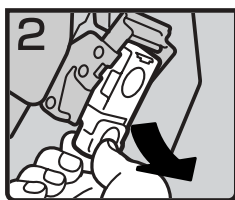

ZGJS802E

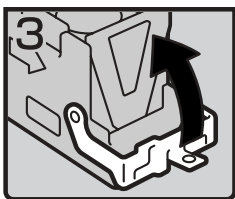

ZGJS813E

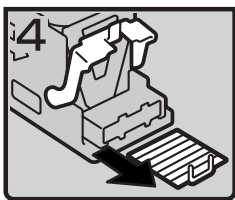

ZGJS814E

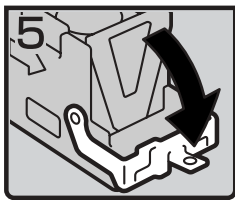

ZGJS815E

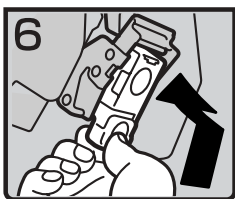

ZGJS864E

- 1: Open the front cover of the finisher, and then pull out the staple unit.
- 2: Hold the green lever while gently pulling out the cartridge.
- 3: Open the cartridge's face plate.
- 4: Remove any jammed staples.
- 5: Pull down the cartridge's face plate until it clicks.
- 6: Hold the green lever while pushing in the cartridge until it clicks.
- 7: Push back the staple unit, and then close the front cover of the finisher.

Replacing the Stamp Cartridge

When the stamp begins to fade, replace the cartridge.

Note

- ❑ This stamp cartridge is used for facsimile and scanner functions.
- ❑ Use the cartridge specified for this machine.
- ❑ Do not attempt to put ink into the cartridge. Doing so will result in leakage.
- ❑ Be sure not to dirty your fingers with ink from the cartridge.

1 Open the ADF unit.

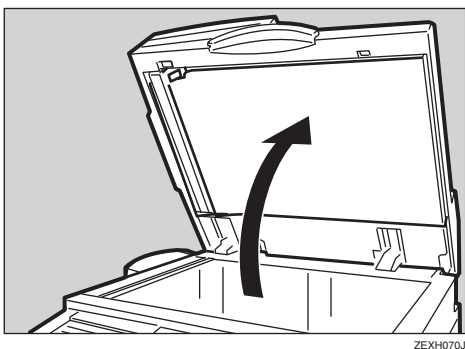

2 Open the stamp cover.

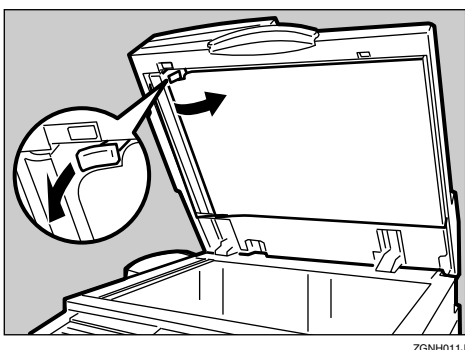

3 Pull out the old stamp cartridge.

Tap the cartridge lock lever several times. The cartridge will eject. Then remove the cartridge, while pushing the lock lever.

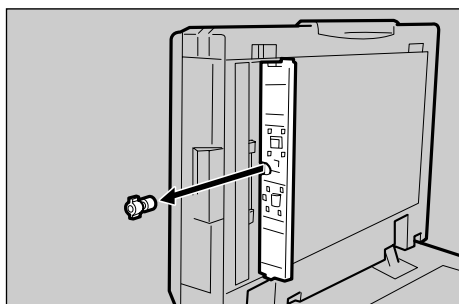

4 Insert the new stamp cartridge.

Insert the cartridge until the metal parts are no longer visible.

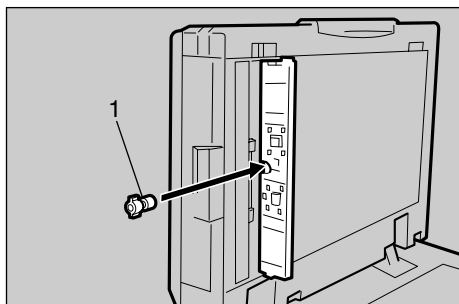

5 Press the stamp cover back in until it clicks.

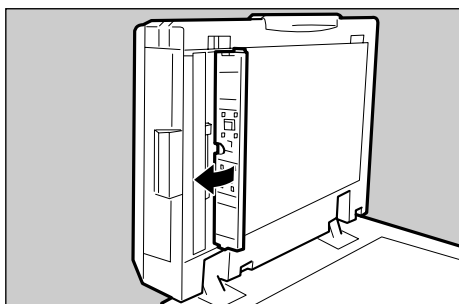

6 Close the ADF unit.

Dos and Don'ts

WARNING:

- **Keep the machine away from flammable liquids, gases, and aerosols. A fire or an electric shock might occur.**

CAUTION:

- *Unplug the power cord from the wall outlet before you move the machine. While moving the machine, you should take care that the power cord will not be damaged under the machine.*

Important

- Do not turn the power off while the On indicator is lit or blinking. Doing so may damage the hard disk.
- Before unplugging the power cord or turning off the main power switch, make sure remaining memory space is at 100%, as shown on the display. See p.26 "Turning Off the Power" and p.26 "Turning Off the Main Power".
- When you use this machine for a long time in a confined space without good ventilation, you may detect an odd smell. To keep the workplace comfortable, we recommend that you keep it well ventilated.
- Do not touch areas on or around the fusing unit. These areas may become hot
- After scanning originals continuously, the exposure glass may become warm—this is not a malfunction.
- The area around the ventilation hole might feel warm. This is caused by exhaust air and is not a malfunction.
- When the machine is not in use and in stand-by mode, you may hear a small noise inside. This is caused by the image stabilization process and is not a malfunction.
- Do not turn off the power when the machine is in operation.
- The machine might not produce good copy images if condensation forms inside as a result of rapid temperature change.
- Do not open the covers of the machine when it is in operation. If you do, misfeeds might occur.
- Do not move the machine when the power is on.
- If you operate the machine improperly or a machine failure occurs, settings might be lost. Be sure to make a note of your machine settings.
- The supplier shall not be liable for any loss or damage resulting from mechanical failure, loss of settings, or use of the machine.

Toner

Handling Toner

 **WARNING:**

- ***Do not incinerate used toner or toner containers. Toner dust might ignite when exposed to an open flame. Dispose of used toner containers in accordance with local regulations.***

 **CAUTION:**

- *Keep toner (used or unused) and toner containers out of reach of children.*

 **Important**

- Fault may occur if you use toner other than the recommended type.

 **Reference**

To add toner, see p.124 “ Adding Toner”.

Toner Storage

When storing toner, the following precautions should always be followed:

- Store toner containers in a cool, dry place free from direct sunlight.
- Store on a flat surface.

Used Toner

 **Note**

- Toner cannot be re-used.

Where to Put Your Machine

Machine Environment

Choose your machine's location carefully. Environmental conditions greatly affect its performance.

Optimum environmental conditions

CAUTION:

- *Keep the machine away from humidity and dust. Otherwise a fire or an electric shock might occur.*
- *Do not place the machine on an unstable or tilted surface. If it topples over, an injury might occur.*

CAUTION:

- *If you use the machine in a confined space, make sure there is a continuous air turnover.*
- Temperature: 10-32 °C (50-89.6 °F) (humidity to be 54% at 32 °C, 89.6 °F)
- Humidity: 15-80% (temperature to be 27 °C, 80.6 °F at 80%)
- A strong and level base.
- The machine must be level within 5 mm, 0.2 inches: both front to rear and left to right.
- To avoid possible buildup of ozone, be sure to locate this machine in a large well ventilated room that has an air turnover of more than 30 m³/hr/person.

Environments to avoid

- Locations exposed to direct sunlight or other sources of strong light (more than 1,500 lux).

- Locations directly exposed to cool air from an air conditioner or heated air from a heater. (Sudden temperature changes can cause condensation to form inside the machine.)
- Locations close to machines generating ammonia, such as a diazo copy machine.
- Places where the machine will be subject to frequent strong vibration.
- Dusty areas.
- Areas with corrosive gases.

Moving

CAUTION:

- *Unplug the power cord from the wall outlet before you move the machine. While moving the machine, you should take care that the power cord will not be damaged under the machine.*

Important

- Be careful when moving the machine. Take the following precautions:
 - Turn off the main power. See p.26 "Turning Off the Main Power".
 - Unplug the power cord from the wall outlet. When you pull out the plug from the socket, grip the plug to avoid damaging the cord, thereby reducing the risk of fire or electric shock.
 - Close all covers and trays, including the front cover and bypass tray.

- ❑ Do not carry the machine, by holding the scanner assembly. Keep the machine level and carry it carefully, taking care not to jolt or tip it. Rough handling may cause a malfunction or damage the hard disk or memory, resulting in loss of stored files.
- ❑ Do not take off the holding stand.
- ❑ Protect the machine from strong shocks. Impact can damage the hard disk and cause stored files to be lost. As a precautionary measure, files should be copied to another computer.

- When the main power switch is in the stand-by position, the optional anti-condensation heaters are on. In an emergency, unplug the machine's power cord.
- When you unplug the power cord, the anti-condensation heaters turn off.
- Make sure the plug is inserted firmly in the wall outlet.
- Voltage must not fluctuate by more than 10%.
- The wall outlet shall be installed near the machine and shall be easily accessible.

Power Connection

⚠ **WARNING:**

- **Connect the machine only to the power source described on the inside front cover of this manual. Connect the power cord directly into a wall outlet and do not use an extension cord.**
- **Do not damage, break or make any modifications to the power cord. Do not place heavy objects on it. Do not pull it hard nor bend it more than necessary. These actions could cause an electric shock or fire.**

⚠ **CAUTION:**

- *Unplug the power cord from the wall outlet before you move the machine. While moving the machine, you should take care that the power cord will not be damaged under the machine.*

⚠ **CAUTION:**

- *When you disconnect the power plug from the wall outlet, always pull the plug (not the cable).*

Access to the Machine

Place the machine near the power source, providing the clearance areas shown.

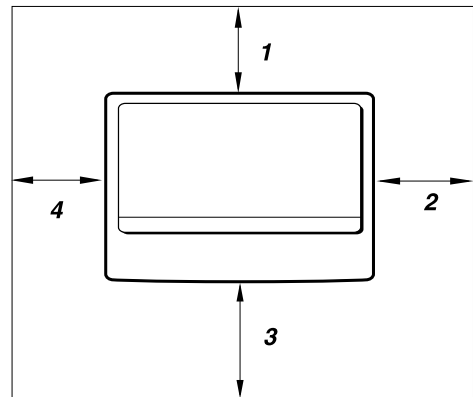

CP999EE

1. Rear: more than 1 cm (4")
2. Right: more than 1 cm (4")
3. Front: more than 75 cm (29.6")
4. Left: more than 1 cm (4")

Note

- ❑ For the required space when options are installed, contact your service representative.

Maintaining Your Machine

If the exposure glass, exposure glass cover, or ADF belt is dirty, copy clarity may be reduced. Clean these parts if they are dirty.

❖ **Cleaning the machine**

Wipe the machine with a soft, damp cloth, and then wipe it with a dry cloth to remove the water.

Important

- ❑ Do not use chemical cleaners or organic solvents, such as thinner or benzene. If such substances get inside the machine or melt plastic parts, a failure might occur.
- ❑ Do not clean parts other than those explicitly specified in this manual. Other parts should only be cleaned by your service representative.

Cleaning the Exposure Glass

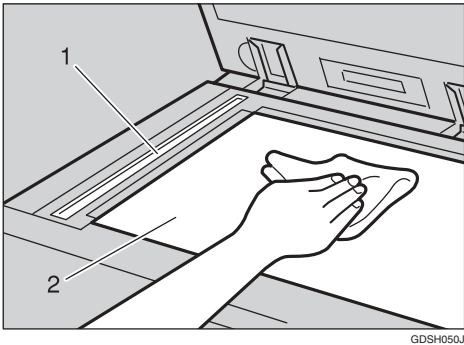

Clean 1 and 2.

Cleaning the Exposure Glass Cover

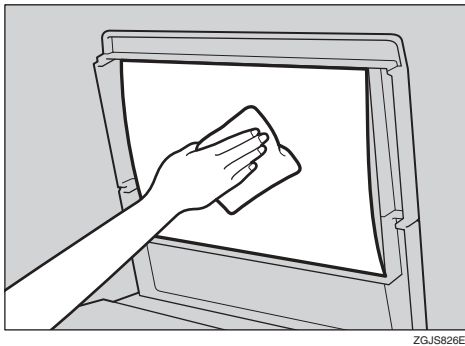

ZGJS826E

Cleaning the Auto Document Feeder

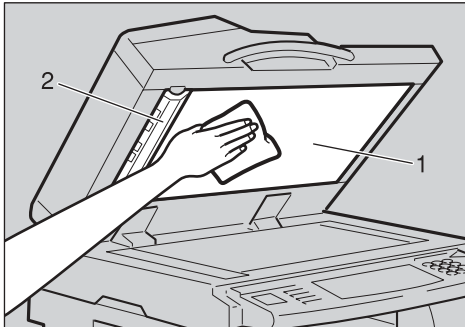

GDSH130J

Clean 1 and 2.

Other Functions

Inquiry

The inquiry function lets you check the telephone numbers to contact for repairs or ordering toner. Be sure to contact your service engineer to verify the following:

❖ Consumables

- Telephone No. to order
- Toner
- Staple
- TX Stamp Name

❖ Machine Maintenance/Repair

- Telephone No.
- Serial No. of Machine

❖ Sales Representative

- Telephone No.

1 Press the **[User Tools/Counter]** key.

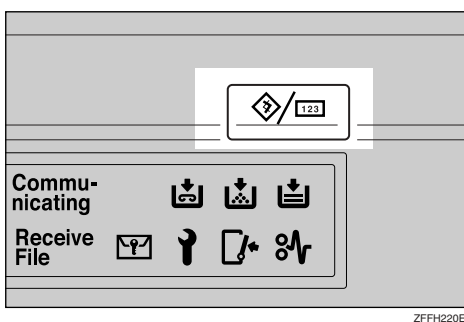

2 Press **[Inquiry]**.

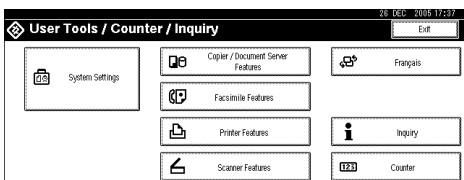

Inquiry information appears.

Printing inquiry information

1 Press **[Print Inquiry List]**.

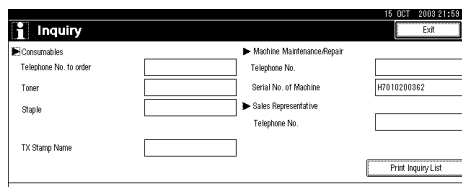

2 Press the **[Start]** key.

Inquiry information is printed.

3 Press **[Exit]**.

4 Press **[Exit]**.

Changing the Display Language

You can change the language used on the display. English is set as default.

1 Press the **[User Tools/Counter]** key.

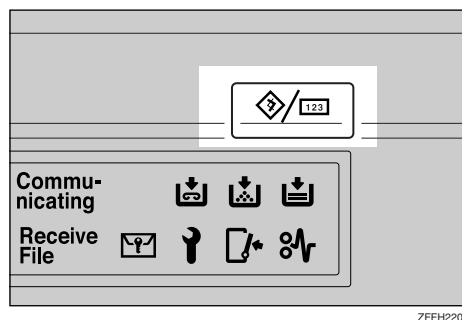

2 Press **[Français]**.

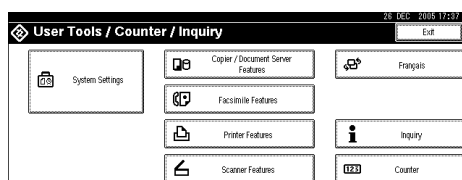

The language is changed to French.

3 Press **[Sortie]**.

The menu appears in French.

Counter

Displaying the Total Counter

You can display the total counter value used for all functions.

- 1 Press the [User Tools/Counter] key.

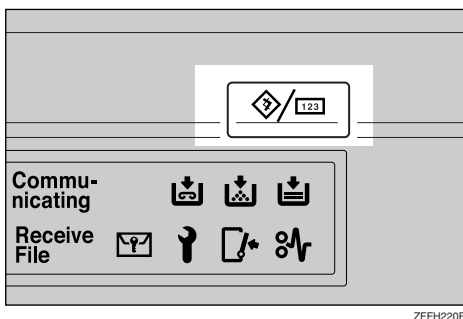

ZFFH220E

- 2 Press [Counter].

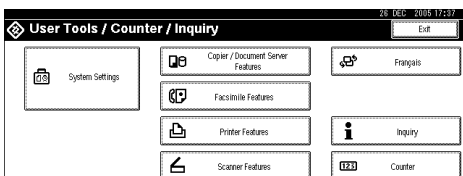

- 3 To print a counter list, press [Print Counter List].

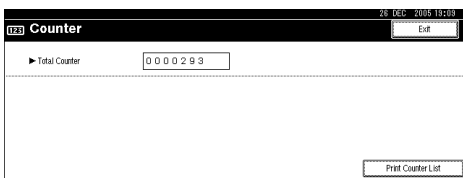

- 4 Press the [Start] key.

A counter list prints out.

8. Entering Text

Entering Text

This section describes how to enter characters. When you enter a character, it appears at the position of the cursor. If there is a character already at the cursor position, the entered character appears before that.

Available Characters

- Alphabetic characters
ABCDEFGHIJKLMNOPQRSTUVWXYZabcdefghijklmnopqrstuvwxyz
- Symbols
- Numerals
0123456789

Keys

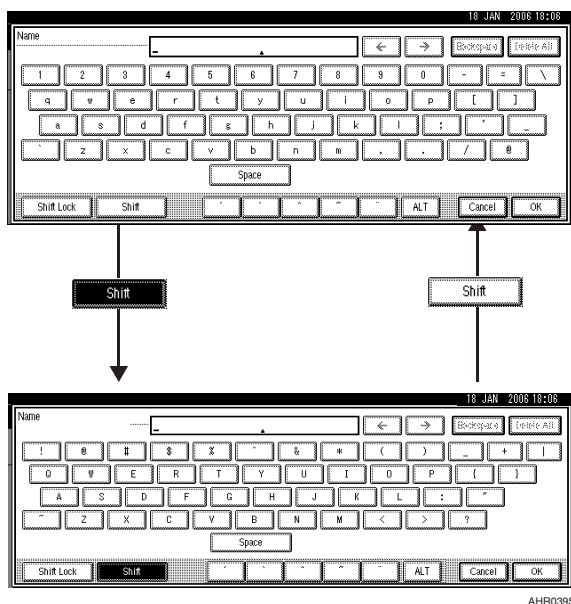

Note

- When entering uppercase or lowercase letters continuously, use **[Shift Lock]** to lock the case.

How to Enter Text

Entering letters

- 1** Press [Shift] to switch between uppercase and lowercase.
 - 2** Press the letters you want to enter.
-

Deleting characters

- 1** Press [Backspace] or [Delete All] to delete characters.

9. Specifications

Main Unit

- ❖ **Configuration:**
Desktop
- ❖ **Photosensitivity type:**
OPC drum (φ30)
- ❖ **Original scanning:**
One-dimensional solid scanning system through CCD
- ❖ **Copy process:**
Dry electrostatic transfer system
- ❖ **Development:**
Dry two-component magnetic brush development system
- ❖ **Fusing:**
Heating roll pressure system
- ❖ **Resolution:**
600 dpi
- ❖ **Exposure glass:**
Stationary original exposure type
- ❖ **Original reference position:**
Rear left corner
- ❖ **Warm-up time:**
 - Main power switch: 12 seconds or less (20 °C, 68 °F)
 - Operation switch: 10 seconds or less (20 °C, 68 °F)
- ❖ **Originals:**
Sheet/book/objects
- ❖ **Maximum original size:**
A3☐, 11" × 17"☐

❖ **Copy paper size:**

- Tray 1: A3☐ – A5☐, 11" × 17"☐ – 5¹/₂" × 8¹/₂"☐
- Tray 2: A3☐ – A6☐, 11" × 17"☐ – 5¹/₂" × 8¹/₂"☐
- Bypass: A3☐ – A6☐, 11" × 17"☐ – 5¹/₂" × 8¹/₂"☐
- Tray 2 (custom size):
Vertical: 100 – 297 mm, 4.0" – 11.7"
Horizontal: 148 – 432 mm, 5.9" – 17.0"
- Bypass (custom size):
Vertical: 90 – 297 mm, 3.6" – 11.7"
Horizontal: 148 – 600 mm, 5.9" – 23.6"
- Duplex: A3☐ – A5☐, 11" × 17"☐ – 5¹/₂" × 8¹/₂"☐ (impossible on A5☐, 5¹/₂" × 8¹/₂" ☐)
- LCT: A4☐, 8¹/₂" × 11"☐

❖ **Copy paper weight:**

- Paper tray 1: 60 – 90 g/m², 16 – 24 lb.
- Paper tray 2: 52 – 157 g/m², 14 – 42 lb.
- Bypass tray: 52 – 157 g/m², 14 – 42 lb.

❖ **Non-reproduction area:**

- Leading edge: 3 ± 2 mm or less
- Trailing edge: 0.5 mm or more
- Left edge: 2 ± 1.5 mm or less
- Right edge: 2 + 2.5/-1.5 mm or less

❖ **First copy time:**

Type 1, 2: 4.4 seconds or less

(A4☐, 8¹/₂" × 11"☐, 100%, feeding from the tray 1, on the exposure glass, Text mode, Auto Image Density)

❖ **Copying speed: (Type 1)**

- 15 copies/minute (A3☐, 11" × 17"☐)
- 17 copies/minute (B4 JIS☐)
- 25 copies/minute (A4☐, 8¹/₂" × 11"☐)

❖ **Copying speed: (Type 2)**

- 17 copies/minute (A3☐, 11" × 17"☐)
- 20 copies/minute (B4 JIS☐)
- 30 copies/minute (A4☐, 8¹/₂" × 11"☐)

❖ **Reproduction ratio:**

Preset reproduction ratios:

	Metric version	Inch version
Enlargement	400%	400%
	200%	200%
	141%	155%
	122%	129%
	115%	121%
Full size	100%	100%
Reduction	93%	93%
	82%	85%
	75%	78%
	71%	73%
	65%	65%
	50%	50%
	25%	25%

Zoom: From 25 to 400% in 1% steps (from 25 to 200% in 1% step, when setting originals in the ADF).

❖ **Maximum continuous copy run:**

999 sheets

❖ **Paper capacity:**

- Tray 1, 2: 500 sheets (80 g/m², 20 lb.)
- Bypass tray: 100 sheets (80 g/m², 20 lb.)

❖ **Power consumption:**

- Main unit only

	Type 1	Type 2
Warm-up	1.27 kW	1.27 kW
Stand-by	about 150 W *2	about 150 W *2
During printing	about 700 W *2	about 800 W *2
Maximum	1.05 kW	1.05 kW

• Complete system *1

	Type 1	Type 2
Warm-up	1.32 kW	1.32 kW
Stand-by	about 150 W *2	about 160 W *2
During printing	about 720 W *2	about 820 W *2
Maximum	1.15 kW	1.15 kW

*1 The Complete system consists of the main unit, 1000-sheet finisher, duplex unit, ADF, bypass tray, inter change unit, internal tray 2, paper tray unit, fax unit, expansion memory, printer unit, File Format Converter, IEEE 1284 Interface Board, HDD and memory unit.

*2 The measurements are actual values.

❖ Dimensions (W × D × H up to exposure glass):

Type 1, 2: 550 × 604 × 980 mm, 21.7" × 23.8" × 38.6"

❖ Space for main unit (W × D):

Type 1, 2: 550 × 604 mm, 21.7" × 23.8"

❖ Noise Emission *1:

Sound Power Level:

• Main unit only

	Type 1	Type 2
Stand-by	40 dB (A)	40 dB (A)
Copying	63 dB (A)	63 dB (A)

• Complete system *3

	Type 1	Type 2
Stand-by	44 dB (A)	44 dB (A)
Copying	68.5 dB (A)	69 dB (A)

Sound Pressure Level *2:

• Main unit only

	Type 1	Type 2
Stand-by	34 dB (A)	34 dB (A)
Copying	57 dB (A)	57 dB (A)

• Complete system *3

	Type 1	Type 2
Stand-by	38 dB (A)	38 dB (A)
Copying	61 dB (A)	61 dB (A)

*1 The above measurements, made in accordance with ISO 7779, are actual values.

*2 Measured at the position of the bystander.

*3 The Complete System consists of the main unit, ADF, 1000-sheet finisher, duplex unit, internal tray 2 and paper tray unit.

❖ **Weight:**

Type 1, 2: Approx. 62 kg, 136.7 lb.

❖ **HDD:**

20 GB or more

- Capacity for Document Server
3.6 GB
- Capacity for memory sorting
3.2 GB
- Capacity for others
1.32 GB or more

Options

Exposure Glass Cover







Lower this over originals for copying.

Auto Document Feeder

❖ **Mode:**

ADF mode, Batch mode, SADP mode, Mixed Size mode, Custom Size originals mode

❖ **Original size:**

- A3  – A5  
- 11" × 17"  – 5¹/₂" × 8¹/₂"  

❖ **Original weight:**

- One-sided originals: 40 – 128 g/m² (11 – 34 lb.)
- Two-sided originals: 52 – 105 g/m² (14 – 28 lb.) (Duplex)

❖ **Maximum number of originals:**

50 sheets (80 g/m², 20 lb.) or less than 11 mm, 0.43"

❖ **Maximum power consumption:**

Less than 50 W (power is supplied from the main unit)

❖ **Dimensions (W×D×H):**

550 × 470 × 130 mm, 21.7" × 18.6" × 5.2"

❖ **Weight:**













Approx. 10 kg, 22.1 lb.

 **Note**

 Specifications are subject to change without notice.

500-Sheet Finisher

❖ **Paper size:**

A3 , B4 JIS , A4  , B5 JIS , 11" × 17" , 11" × 14" , 8¹/₂" × 14" , 8¹/₂" × 11"  , 8¹/₂" × 13" , 8" × 10¹/₂" 

❖ **Paper weight:**

60 – 128 g/m², 16 – 34 lb.

❖ **Stack capacity:**

- 500 sheets (A4 \square , $8\frac{1}{2}$ " \square \times 11" \square or smaller) (80 g/m², 20 lb.)
- 250 sheets (B4 JIS \square , $8\frac{1}{2}$ " \square \times 14" \square or larger) (80 g/m², 20 lb.)

❖ **Staple capacity:**

- 30 sheets (A4 \square , $8\frac{1}{2}$ " \square \times 11" \square or smaller) (80 g/m², 20 lb.)
- 20 sheets (B4 JIS \square , $8\frac{1}{2}$ " \square \times 14" \square or larger) (80 g/m², 20 lb.)

❖ **Staple paper size:**

A3 \square , B4 JIS \square , A4 \square \square , B5 JIS \square , 11" \times 17" \square , 11" \times 15" \square , 11" \times 14" \square , 10" \times 14" \square , 10" \times 15" \square , $8\frac{1}{2}$ " \times 14" \square , $8\frac{1}{2}$ " \times 13" \square , $8\frac{1}{2}$ " \times 11" \square \square , 8" \times 10 $\frac{1}{2}$ " \square , 8" \times 10" \square , 10 $\frac{1}{2}$ " \times 7 $\frac{1}{4}$ " \square

❖ **Staple paper weight:**

64 – 90 g/m², 17 – 24 lb.

❖ **Staple position:**

1 position (upper left)

❖ **Power consumption:**

48 W (power is supplied from the main unit)

❖ **Dimensions (W \times D \times H):**

350 \times 490 \times 230 mm, 13.8" \times 19.3" \times 9.1"

❖ **Weight:**

Approx. 10 kg, 22.1 lb.

1000-Sheet Finisher

Finisher Upper Tray:

❖ **Paper size:**

A3 \square , B4 JIS \square , A4 \square \square , B5 JIS \square \square , A5 \square \square , B6 JIS \square , A6 \square , Postcard \square , 11" \times 17" \square , 11" \times 15" \square , 11" \times 14" \square , 10" \times 14" \square , 10" \times 15" \square , $8\frac{1}{2}$ " \times 14" \square , $8\frac{1}{2}$ " \times 11" \square \square , 10 $\frac{1}{2}$ " \times 7 $\frac{1}{4}$ " \square \square , 8" \times 13" \square , $8\frac{1}{2}$ " \times 13" \square , $8\frac{1}{4}$ " \times 13" \square , 8" \times 10 $\frac{1}{2}$ " \square \square , 8" \times 10" \square \square , $8\frac{1}{4}$ " \times 14" \square , $5\frac{1}{2}$ " \times $8\frac{1}{2}$ " \square \square

❖ **Paper weight:**

60 – 157 g/m², 16 – 42 lb.

❖ **Stack capacity:**

- 250 sheets (A4 \square , $8\frac{1}{2}$ " \square \times 11" \square or smaller) (80 g/m², 20 lb.)
- 50 sheets (B4 JIS \square , $8\frac{1}{2}$ " \square \times 14" \square or larger) (80 g/m², 20 lb.)

Finisher Shift Tray:

❖ **Paper size:**

A3, B4 JIS, A4, B5 JIS, 11" × 17", 11" × 14", 8½" × 14", 8½" × 11", 10½" × 7¼", 8" × 10½", 8" × 13", 8½" × 13", 8¼" × 13", 8¼" × 14", 5½" × 8½"

❖ **Paper weight:**

60 – 157 g/m², 16 – 42 lb.

❖ **Stack capacity:**

- 1,000 sheets (A4, 8½" × 11" or smaller) (80 g/m², 20 lb.)
- 500 sheets (B4 JIS, 8½" × 14" or larger) (80 g/m², 20 lb.)

❖ **Staple capacity:**

- 50 sheets (A4, 8½" × 11" or smaller) (80 g/m², 20 lb.)
- 30 sheets (B4 JIS, 8½" × 14" or larger) (80 g/m², 20 lb.)

❖ **Staple paper size:**

A3, B4 JIS, A4, B5 JIS, 11" × 17", 11" × 15", 11" × 14", 10" × 14", 10" × 15", 8½" × 14", 8½" × 11", 10½" × 7¼", 8" × 13", 8½" × 13", 8¼" × 13", 8" × 10½", 8" × 10", 8¼" × 14"

❖ **Staple paper weight:**

64 – 90 g/m², 17 – 24 lb.

❖ **Staple position:**

- 1 staple – 2 positions
- 2 staples – 2 positions

❖ **Power consumption:**

Less than 50 W (power is supplied from the main unit)

❖ **Dimensions (W × D × H):**

527 × 520 × 790 mm, 20.8" × 20.5" × 31.1"

❖ **Weight:**

Approx. 25 kg, 55.2 lb.

Shift Sort Tray

❖ **Paper capacity:**

250 sheets (A4, 8½" × 11" or smaller) (80 g/m², 20 lb.)
 125 sheets (B4 JIS, 8½" × 14" or larger) (80 g/m², 20 lb.)

❖ **Power consumption:**

3.6 W (power is supplied from the main unit)

❖ **Dimensions (W × D × H)**

430 × 372 × 148 mm, 17" × 15" × 6"

❖ **Weight:**

Approx. 1.6 kg, 3.5 lb.

Duplex Unit

❖ **Paper size:**

A3☐, B4 JIS☐, A4☐☐, B5 JIS☐☐, A5☐, 5¹/₂" × 8¹/₂"☐, 7¹/₄" × 10¹/₂"☐☐, 8" × 10"☐☐, 8¹/₂" × 11"☐☐, 8" × 13"☐, 8¹/₂" × 13"☐, 8¹/₂" × 14"☐, 8¹/₄" × 13"☐, 11" × 17"☐

❖ **Paper weight:**

64 – 90 g/m², 20 – 24 lb.

❖ **Power consumption (Max):**

35 W (power is supplied from the main unit)

❖ **Dimensions (W × D × H):**

90 × 495 × 455 mm, 3.6" × 19.5" × 17.9"

❖ **Weight:**

Approx. 6 kg, 13.3 lb.

Bypass Tray

❖ **Paper size:**

- Standard size: A3☐ – A6☐, 11" × 17"☐ – 5¹/₂" × 8¹/₂"☐
- Custom size: Vertical (90 – 297 mm, 3.6" – 11.7"), Horizontal (148 – 600 mm, 5.9" – 23.6")

❖ **Paper weight:**

52 – 157 g/m², 14 – 42 lb.

❖ **Dimensions (W × D × H):**

296 × 495 × 163 mm, 11.7" × 19.5" × 6.5"

❖ **Paper capacity:**

52 – 90 g/m², 16 – 20 lb: 100 sheets

❖ **Weight:**

Approx. 2.5 kg, 5.6 lb.

Bridge Unit

- ❖ **Dimensions:**
413 × 435 × 126 mm, 16.3" × 17.1" × 5.0"
- ❖ **Weight:**
3.6 kg, 7.9 lb.

Internal Tray 2 (1 bin tray)

- ❖ **Number of bins:**
1
- ❖ **Available paper size:**
A3☐, B4 JIS☐, A4☐☐, B5 JIS☐☐, A5☐, 11" × 17"☐, 8¹/₄" × 14"☐, 8¹/₂" × 14"☐, 11" × 15"☐, 11" × 14"☐, 10" × 14"☐, 10" × 15"☐, 8¹/₂" × 11"☐☐, 10¹/₂" × 7¹/₄"☐☐, 8" × 13"☐, 8¹/₂" × 13"☐, 8¹/₄" × 13"☐, 8" × 10¹/₂"☐☐, 8" × 10"☐☐, 5¹/₂" × 8¹/₂"☐
- ❖ **Paper capacity:**
125 sheets (80 g/m², 20 lb.)
- ❖ **Paper weight:**
60 – 90 g/m² (16 – 24 lb.)
- ❖ **Maximum power consumption:**
Less than 15 W (power is supplied from the main unit)
- ❖ **Dimensions (W × D × H):**
530 × 410 × 120 mm, 20.9" × 16.2" × 4.7"
- ❖ **Weight:**
Approx. 1.1 kg, 2.5 lb.



Note

- ☐ Specifications are subject to change without notice.

Large Capacity Tray

- ❖ **Paper size:**
A4☐, 8¹/₂" × 11"☐
- ❖ **Paper weight:**
60 – 90 g/m², 16 – 24 lb.
- ❖ **Paper capacity:**
2,000 sheets (80 g/m², 20 lb.)

❖ **Power consumption**

Maximum. 40 W (power is supplied from the main unit)

❖ **Dimensions (W × D × H, option unit):**

550 × 520 × 271 mm, 21.7" × 20.5" × 10.7"

❖ **Weight:**

Approx. 25 kg, 55.2 lb.

 **Note**

Specifications are subject to change without notice.

Paper Tray Unit

❖ **Paper weight:**

60 – 90 g/m² (16 – 24 lb.)

❖ **Available paper size:**

A3 , B4 JIS , A4 , B5 JIS , A5 , 11" × 17" , 8¹/₂" × 14" , 8¹/₂" × 11" ,
5¹/₂" × 8¹/₂" , 8¹/₄" × 14" , 11" × 14" , 7¹/₄" × 10¹/₂" , 8" × 13" , 8" × 10¹/₂" ,
8¹/₂" × 13" , 8¹/₄" × 13"

❖ **Maximum power consumption:**

Less than 30 W (power is supplied from the main unit)

❖ **Paper capacity:**

500 sheets (80 g/m², 20 lb.) × 2 trays

❖ **Dimensions (W × D × H):**

550 × 520 × 271 mm, 21.7" × 20.5" × 10.7"

❖ **Weight:**

Approx. 25 kg, 55.2 lb.

 **Note**

Specifications are subject to change without notice.

Copy Paper

Recommended Paper Sizes and Types

The following limitations apply to each tray:

Tray Type	Paper Type and Weight	Metric Version	Inch Version	Paper Capacity
Tray 1 ^{*10}	60-90 g/m ² (16-24 lb.)	A3☐, B4 JIS☐, A4☐☐, B5 JIS☐☐, A5☐		500 sheets
		^{*1} 11"×17"☐, 8 ¹ / ₂ "×14"☐, 8 ¹ / ₂ "×11"☐☐, 8"×13"☐, 8 ¹ / ₂ "×13"☐, 8 ¹ / ₄ "×13"☐, 8 ¹ / ₄ "×14"☐, 11"×14"☐, 7 ¹ / ₄ "×10 ¹ / ₂ "☐, 8"×10 ¹ / ₂ "☐☐, 5 ¹ / ₂ "×8 ¹ / ₂ "☐, 8K☐, 16K☐☐		
		^{*2} Custom size Vertical: 140-297 mm Horizontal: 182-432 mm	^{*2} Custom size Vertical: 5.6"-11.7" Horizontal: 7.3"-17.0"	
Tray 2 ^{*10}	60-90 g/m ² (16-24 lb.) Thin paper 52-60 g/m ² (14-16 lb.)	A3☐, B4 JIS☐, A4☐☐, B5 JIS☐☐, A5☐		500 sheets
		^{*1} B6 JIS☐, A6☐, 11"×17"☐, 8 ¹ / ₂ "×14"☐, 8 ¹ / ₂ "×11"☐☐, 5 ¹ / ₂ "×8 ¹ / ₂ "☐, 7 ¹ / ₄ "×10 ¹ / ₂ "☐☐, 8"×13"☐, 8 ¹ / ₂ "×13"☐, 8 ¹ / ₄ "×13"☐, 8"×10"☐☐, 8 ¹ / ₄ "×14"☐, 11"×14"☐, 8"×10 ¹ / ₂ "☐☐, 11"×15"☐, 10"×14"☐, 10"×15"☐, 8K☐, 16K☐☐		
		^{*2} Custom size Vertical: 100-297 mm Horizontal: 148-432 mm	^{*2} Custom size Vertical: 4.0"-11.7" Horizontal: 5.9"-17.0"	
	Thick paper ^{*11} 105-157 g/m ² (28-42 lb.)	A3☐, B4 JIS☐, A4☐☐, B5 JIS☐☐, A5☐		^{*7}
		^{*1} B6 JIS☐, A6☐, 11"×17"☐, 8 ¹ / ₂ "×14"☐, 8 ¹ / ₂ "×11"☐☐, 5 ¹ / ₂ "×8 ¹ / ₂ "☐, 7 ¹ / ₄ "×10 ¹ / ₂ "☐☐, 8"×13"☐, 8 ¹ / ₂ "×13"☐, 8 ¹ / ₄ "×13"☐, 8"×10"☐☐, 8 ¹ / ₄ "×14"☐, 11"×14"☐, 8"×10 ¹ / ₂ "☐☐, 11"×15"☐, 10"×14"☐, 10"×15"☐, 8K☐, 16K☐☐		
		^{*2} Custom size Vertical: 100-297 mm Horizontal: 148-432 mm	^{*2} Custom size Vertical: 4.0"-11.7" Horizontal: 5.9"-17.0"	
	Translucent paper	A3☐, B4 JIS☐, A4☐☐, B5 JIS☐☐		
	OHP transparencies	A4☐☐		
	Postcards	100 × 148 mm		
	Label paper (adhesive labels)	B4 JIS☐, A4☐		
Envelope	3 ⁷ / ₈ "×7 ¹ / ₂ "☐, 4 ¹ / ₈ "×9 ¹ / ₂ "☐, C5 Env☐, C6 Env☐, DL Env☐		–	

Tray Type	Paper Type and Weight	Metric Version	Inch Version	Paper Capacity
Bypass Tray ^{*10} (optional)	Thin paper 52-90 g/m ² (14-24 lb.) 52-60 g/m ² (14-16 lb.)	A3☐, B4 JIS☐, 11" × 17"☐, 8 ¹ / ₂ " × 14"☐, 8" × 13"☐, 8 ¹ / ₂ " × 13"☐, 8 ¹ / ₄ " × 13"☐, 8 ¹ / ₄ " × 14"☐, 11" × 14"☐, 11" × 15"☐, 10" × 14"☐, 10" × 15"☐, 8K☐		10 sheets
		A4☐☐, B5 JIS☐☐, A5☐☐, B6 JIS☐☐		100 sheets
		* ³ A6☐, 8 ¹ / ₂ " × 11"☐☐, 5 ¹ / ₂ " × 8 ¹ / ₂ "☐, 7 ¹ / ₄ " × 10 ¹ / ₂ "☐☐, 8" × 10"☐☐, 8" × 10 ¹ / ₂ "☐☐, 16K☐☐		
		* ⁴ Custom size Vertical: 90-297 mm Horizontal: 148-600 mm ^{*12}	* ⁴ Custom size Vertical: 3.6"-11.7" Horizontal: 5.9"-23.6" ^{*12}	* ⁸
	Thick paper ^{*11} 105-157 g/m ² (28-42 lb.)	A3☐, B4 JIS☐, 11" × 17"☐, 8 ¹ / ₂ " × 14"☐, 8" × 13"☐, 8 ¹ / ₂ " × 13"☐, 8 ¹ / ₄ " × 13"☐, 8 ¹ / ₄ " × 14"☐, 11" × 14"☐, 11" × 15"☐, 10" × 14"☐, 10" × 15"☐, 8K☐		10 sheets
		A4☐☐, B5 JIS☐☐, A5☐☐, B6 JIS☐☐		40 sheets
		* ³ A6☐, 8 ¹ / ₂ " × 11"☐☐, 5 ¹ / ₂ " × 8 ¹ / ₂ "☐, 7 ¹ / ₄ " × 10 ¹ / ₂ "☐☐, 8" × 10"☐☐, 8" × 10 ¹ / ₂ "☐☐, 16K☐☐		
		* ⁴ Custom size Vertical: 90-297 mm Horizontal: 148-600 mm ^{*12}	* ⁴ Custom size Vertical: 3.6"-11.7" Horizontal: 5.9"-23.6" ^{*12}	* ⁹
	Translucent paper	A3☐, B4 JIS☐		10 sheets
		A4☐☐, B5 JIS☐☐		40 sheets ^{*5}
OHP transparencies	A4☐☐		10 sheets ^{*5}	
Postcards	100 × 148 mm		40 sheets ^{*5}	
Label paper (adhesive labels)	B4 JIS☐, A4☐		1 sheet	
Envelope	3 ⁷ / ₈ " × 7 ¹ / ₂ "☐, 4 ¹ / ₈ " × 9 ¹ / ₂ "☐, C5 Env☐, C6 Env☐, DL Env☐		–	
LCT ^{*10} (optional)	60-90 g/m ² (16-24lb.)	A4☐, 8 ¹ / ₂ " × 11"☐ ^{*6}		2000 (1000 + 1000) sheets

^{*1} Set the paper size selector to the ✱ mark, and then select the paper size in System Settings. See "Paper Type".

^{*2} Set the paper size selector to the ✱ mark, and then specify the paper size. See "Copying from the paper tray 2", *Copy Reference*





^{*3} Place the paper in the bypass tray, and select the paper size. See "When copying onto standard size paper", *Copy Reference*

^{*4} Place the paper in the bypass tray, and specify the paper size. See "When copying onto custom size paper", *Copy Reference*

When paper larger than 433 mm is used, it is likely to jam, crease or not feed in properly. Make sure the paper is placed correctly so that it feeds in straight.

^{*5} Placing one sheet at a time is recommended.

^{*6} The paper tray guide is fixed. If you want to change the size of paper placed in this tray, contact your service representative.

- *7 When loading paper, make sure the stack height does not exceed the lower limit mark of the paper tray 2. See p.121 "Setting special paper in the paper tray 2".
- *8 When the paper size is larger than A4 , you can load 10 sheets.
When the paper size is smaller than A4 , you can load 100 sheets.
- *9 When the thick paper size is larger than A4 , you can load 10 sheets. When the thick paper size is smaller than A4 , you can load 40 sheets.
- *10 When loading copy paper, make sure the stack height does not exceed the limit mark. The maximum number of sheets you can load at a time depends on the paper thickness and condition.
- *11 If you want to copy onto thick (105 g/m², 28 lb or heavier) paper, select Thick Paper mode. See "Copying from the Paper Tray 2", Copy Reference.
- *12 Paper size up to 600 mm (23.6") is available when the optional HDD is installed.

Important

- Damp or curled paper may cause misfeeds.

Note

- When loading paper in the paper tray 1-4 and the LCT, place the copy side of the paper face up.
- When loading paper in the bypass tray, place the copy side of the paper face down.
- When using the bypass tray, it is recommended to set the paper orientation to .
- If you load paper of the same size in the same orientation in two or more trays, the machine automatically shifts to the other tray when the first tray in use runs out of paper. This function is called Auto Tray Switching. (However, if the Paper Type of one tray is recycled or special paper, the settings of the other trays must be the same for Auto Tray Switching to work.) This saves interrupting a copy run to replenish paper when making a large number of copies. See "Selecting Copy Paper", "Auto Tray Switching", *Copy Reference*
- The paper types you can select in System Settings are only general classifications. Copy quality for every kind of paper in a classification is not guaranteed. See p.165 "Unusable Paper" for more information.

Unusable Paper

CAUTION:

- *Do not use aluminum foil, carbon paper, or similar conductive paper to avoid a fire or machine failure.*

Important

- To prevent faults, do not use any of the following kinds of paper:
 - Paper for inkjet printers
 - Thermal fax paper
 - Art paper
 - Aluminum foil
 - Carbon paper
 - Conductive paper
 - OHP transparencies for colour copying
 - Paper with perforated lines
 - Hemmed paper
- Do not use copy paper that has been already copied onto, fault could occur if you do.

Note

- To prevent misfeeds, do not use the following kinds of paper:
 - Bent, folded, or creased paper
 - Torn paper
 - Slippery paper
 - Perforated paper
 - Rough paper
 - Thin paper with little stiffness
 - Paper with a dusty surface
- If you copy onto rough grain paper, the image might be blurred.

Paper Storage

Note

- When storing paper, the following precautions should always be followed:
 - Do not store paper where it will be exposed to direct sunlight.
 - Avoid storing paper in humid areas (humidity: 70% or less).
 - Store on a flat surface.
- Do not store paper vertically.
- Under high temperature and humidity conditions, or low temperature and humidity conditions, store paper in vinyl bags.

INDEX

1000-Sheet Finisher, 157
1000-sheet finisher, 19
500-Sheet Finisher, 19

A

Adding a Group to Another Group, 105
Adding staples, 135
Adding toner, 124
Address Book
 Change Order, 65
 Program / Change / Delete Group, 65
Address book, 69
 edit title, 66
 select title, 67
Address Book Management, 64
ADF, 19
Administrator Authentication Management, 62
Administrator Tools, 62
AOF (Always ON), 68
Authentication Information, 74
Auto Delete File in Document Server, 67
Auto Document Feeder, 17, 156
 cleaning, 145
Auto Off, 27
Auto off timer, 59
Auto reset timer
 copier/Document Server, 60
 facsimile, 60
 printer, 60
 scanner, 61
 system, 60

B

Bridge unit, 19, 160
Browse network, 93
Bypass tray, 18, 19, 159

C

Changing a group name, 104
Changing a name Registered Name, 73
Changing a registered e-mail destination, 89
Changing a registered fax destination, 82
Changing a registered folder, 93, 96
Changing a Registered IP-Fax
 Destination, 85
Changing a registered
 Transfer Station/Receiving Station, 111
Changing a user code, 75

Changing paper, 132
Changing the language, 146
Changing the paper size, 132
Check Modes key, 21
Clear
 counter per user code, 63
Clearing misfeeds, 127
Clearing the number of prints, 77
Clear Modes key, 21
Clear/Stop key, 22
Combined function operations, 29
Common key operations, 23
Control panel, 18, 21
Copy Count Display, 53
Copy paper, 162
Cover sheet tray, 58

D

Delete All Files in Document Server, 67
Delete All Logs, 68
Deleting a group, 105
Deleting a registered e-mail destination, 90
Deleting a registered fax destination, 83
Deleting a registered folder, 94, 97
Deleting a registered
 Transfer Station/Receiving Station, 112
Deleting a user, 73
Deleting a user code, 76
Display
 counter per user code, 63
Displaying names registered in groups, 103
Displaying the Counter for each user code, 76
Displaying the Total Counter, 147
Display panel, 21, 23
Display / Print Counter, 63
Document Server, 35
 Deleting, 45
 Printing, 42
 Using the Document Server, 37
Do's and Don'ts, 141
Duplex unit, 19, 159

E

E-mail destination, 88
Energy Saver key, 21
Entering text, 149
Environment, 143
Exposure glass, 17
 cleaning, 145

Exposure glass cover, 19
 cleaning, 145
Extended Security, 63
External options, 19

F

Fax destination, 79
Finisher
 1000-Sheet Finisher, 19
 500-Sheet Finisher, 19
Firmware Version, 68
Front cover, 18
FTP, 95
Function keys, 22
Function Priority, 53
Function reset timer, 54
Function status indicators, 22

I

Indicators, 21
Inquiry, 146
Inter change unit, 19
Internal options, 20
Internal tray, 17
Internal tray 2 (1 bin tray), 19
Interrupt key, 22

K

key, 22
Key Counter Management, 63

L

Large Capacity Tray, 160
Large Capacity Tray (LCT), 19
LCT, 160
Loading Paper
 Large Capacity Tray, 122
Loading paper, 121
 paper tray, 121

M

Machine environment, 143
Main power indicator, 17, 22
Main power switch, 17, 25
Maintaining Your Machine, 145
Main Unit, 151
Misfeeds, 127
Moving, 143
Multi-Access, 31

N

NCP, 98
Network Security Level, 68
Number keys, 22

O

Operation switch, 22, 25
Options, 156

P

Panel off timer, 60
Panel Tone, 53
Paper
 changing, 132
 loading, 121
Paper tray, 18
Paper tray 2, 18
Paper tray priority
 copier, 56
 facsimile, 56
 printer, 56
Paper tray unit, 19
Paper type
 bypass tray, 57
 tray 1-4, 58
Power connection, 144
Power indicator, 22
Print
 address book, 66
 counter per user code, 63
Printing the Counter for each user code, 76
Print Priority, 53
Program / Change Administrator, 62
Program / Change / Delete LDAP Server, 67
Program key, 21
Protection
 code, 107, 108
 destination, 107

R

Receiving Station, 109
Reduce Recovery Time, 68
Registering a fax destination, 80
Registering a name, 72
Registering an e-mail destination, 88
Registering a New Group, 102
Registering a new user code, 74
Registering an IP-Fax Destination, 84
Registering a protection code, 107
Registering a protection code to a group user, 108
Registering a protection code to a single user, 107

Registering a Transfer Station/
Receiving Station, 109
Registering Authentication, 113
Registering Folders, 91
Registering Names, 72
Registering names to a group, 102, 103
Registering the Transfer Request, 109
Remarks, 141
Remove Paper Indicator, 18
Removing a name from a group, 104
Removing jammed staples, 138

S

Safety information, 10
Sample Copy key, 22
Saving energy, 27
Screen contrast knob, 21
Set date, 61
Set time, 61
Shift sort tray, 19
Slip sheet tray, 59
SMB, 91
Specification
 Duplex unit, 159
 Shift Sort Tray, 158
Specifications, 151
 1000-Sheet Finisher, 157
 Auto Document Feeder, 156
 bridge unit, 160
 internal tray 2 (1 bin tray), 160
 Large Capacity Tray (LCT), 160
 main unit, 151
 paper tray unit, 161
Staples
 adding, 135
 removing jammed staples, 138
Start key, 22
System Reset, 30

T

Toner, 142
 adding, 124
 storage, 142
To register an FTP folder, 95
To register an SMB folder, 91
Transfer Log Setting, 68
Transfer Station, 109
Tray paper size, 56

U

Unauthorized Copy Control, 68
Use LDAP Server, 68
User Authentication Management, 62
User Tools/Counter key, 21
User Tools (System Settings), 49
Using FTP to Connect, 95
Using NCP to Connect, 98
Using SMB to Connect, 91

V

Ventilation holes, 17

W

Warm Up Notice (copier/Document Server), 53
Web Image Monitor, 46



Declaration of Conformity

“The Product complies with the requirements of the EMC Directive 89/336/EEC and its amending directives and the Low Voltage Directive 73/23/EEC and its amending directives.”

In accordance with IEC 60417, this machine uses the following symbols for the main power switch:

I means **POWER ON.**

⏻ means **STAND BY.**

LANIER



your document management partner

www.lanier-europe.com

*Customer Vision - our commitment to your
complete satisfaction*



Lanier Europe B.V.

Drève de Willerieken, 20

B-1160 Brussels, Belgium

GB  B209-6530